

AGRICULTURAL PARTS

44 SERIES

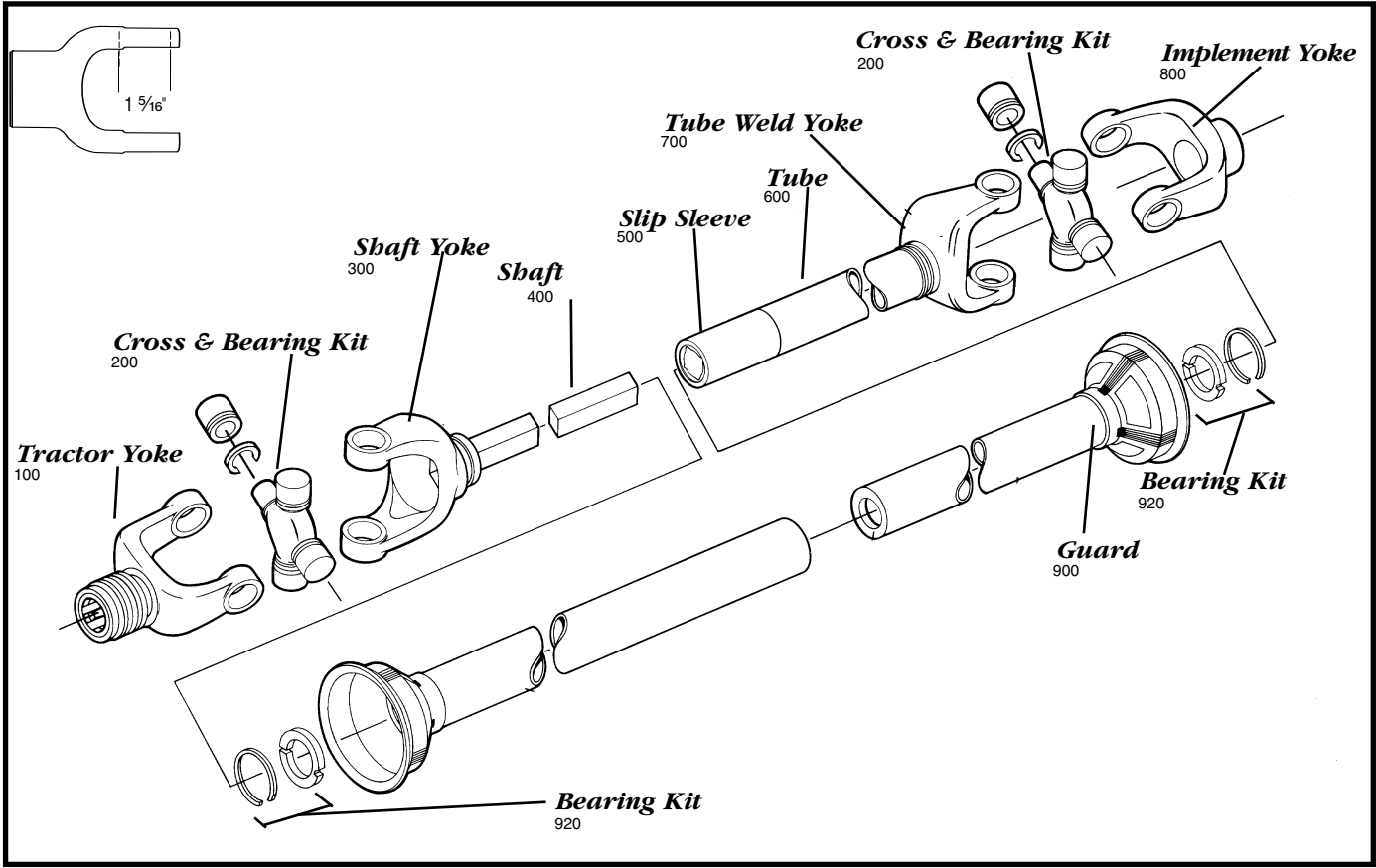

Tractor Yoke

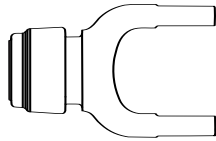
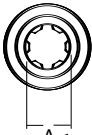

Safety Slide Lock

SPECIFICATIONS		
RB&H #	REFERENCE #	DIM. "A" BORE (IN.)
101-4406	44R220-20-SS	1 3/8 x 6
101-4421	44R220-TQD-SS	1 3/8 x 21
101-4420	-	1 3/4 x 20

Cross & Bearing Kit

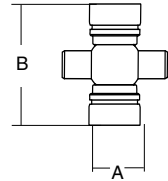

SPECIFICATIONS			
RB&H #	REFERENCE #	DIM. "A" BORE (IN.)	DIM. "B" BORE (IN.)
200-4400	44R	1 5/16	4
201-4400	Extended Life	1 5/16	4

Snap ring located in bushing

Quick Disconnect

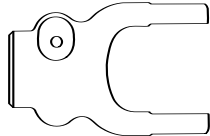
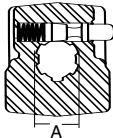

SPECIFICATIONS		
RB&H #	REFERENCE #	DIM. "A" BORE (IN.)
102-4406	44R220-20	1 3/8 x 6
102-4420	-	1 3/4 x 20
102-4421	44R220-TQD	1 3/8 x 21

Repair kit — page 200

Shaft Weld Yoke

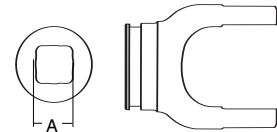

SPECIFICATIONS		
RB&H #	REFERENCE #	DIM. "A" BORE (IN.)
300-4400	44RWY2100	1 5/16 sq.

With bearing groove
(Guard must rotate freely on yoke)

AGRICULTURAL PARTS

44 SERIES

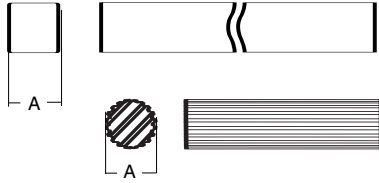

Shaft

SPECIFICATIONS				
RB&H #	REFERENCE #	DIM. "A" BORE (IN.)	LENGTH (IN.)	SHAPE
400-0021	B1312	1 5/16	6	Square
404-2720	-	1 11/16 x 20	3	Round

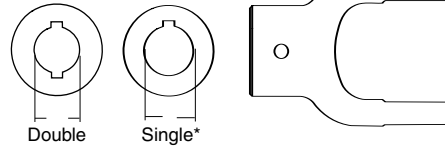

Implement Yoke

Double Single*

Round Bore

SPECIFICATIONS		
RB&H #	REFERENCE #	DIM. "A" BORE (IN.)
806-4420	1/4	5/16 & 1/4
806-4422	1 3/8	5/16 & 1/4
800-4423*	1 7/16	3/8
806-4424	1 1/2	5/16 & 3/8
800-4426*	1 5/8	3/8
800-4428*	1 3/4	3/8
800-4432*	2	1/2

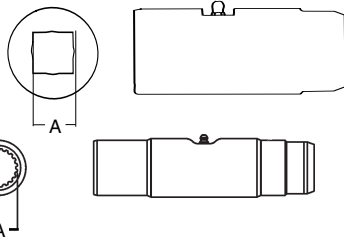

Slip Sleeve

SPECIFICATIONS					
RB&H #	REFERENCE #	LENGTH (IN.)	DIM. "A" BORE (IN.)	FITS TUBE SIZE (IN.)	SHAPE
500-4400	44-55RS06	5	1 5/16	2 1/2 (.134 Wall)	Square
503-3500	-	8	1 11/16 x 20	2 1/2	Round

With grease groove

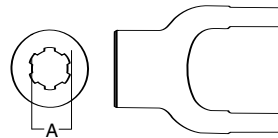

Spline Bore

SPECIFICATIONS		
RB&H #	REFERENCE #	DIM. "A" BORE (IN.)
801-4406	44R220-21	1 3/8 x 6 Spline
801-4421	44R220-T	1 3/8 x 21 Spline

With 2 1/8" pin hole



Tube

2 1/2" (.120 Wall)

SPECIFICATIONS		
RB&H #	REFERENCE #	LENGTH (IN.)
602-4400	44RTT	6

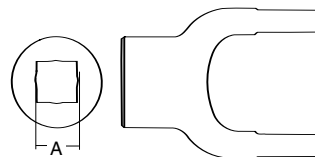

Square Bore

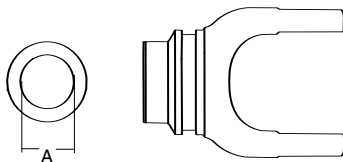

Tube Weld Yoke

SPECIFICATIONS		
RB&H #	REFERENCE #	DIM. "A" BORE (IN.)
804-4418	44R180-26	1 1/8

With set screw

SPECIFICATIONS		
RB&H #	REFERENCE #	DIM. "A" BORE (IN.)
701-4400	44RWY2200	2 1/2 (.120 Wall)

With bearing groove
(Guard must rotate freely on yoke)

AGRICULTURAL PARTS

44 SERIES

Guard

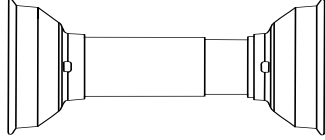

Plastic Guard

SPECIFICATIONS	
RB&H #	OVERALL DRIVELINE LENGTH (IN.)
902-3548	48
902-3560	60

NOTE: When installing bearings (921-4400) guards observe the following:

- 1) Install proper nylon bearing and retainer
- 2) Check to insure guards turn freely on bearing

Yoke, Tube & Sleeve Assembly

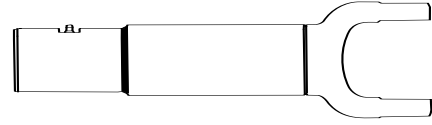

1 5/16" Square

SPECIFICATIONS		
RB&H #	REFERENCE #	CENTERLINE TO END OF TUBE DIMENSION LENGTH (IN.)
11004448	44R48F	35.62

Yoke & Shaft Assembly

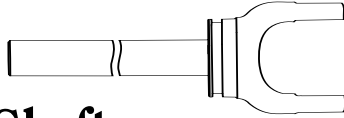

1 5/16" Square Shaft

SPECIFICATIONS		
RB&H #	REFERENCE #	CENTERLINE TO END OF SHAFT DIMENSION LENGTH (IN.)
10004448	44R48M	33.12