

AIR CONDITIONING HOSE AND FITTING INFORMATION

AIR CONDITIONING

A/C Hose Material: Size Explanation

A/C Hose size is determined by the inside and outside diameter of the hose. Outside diameters of hoses vary significantly and **MUST NOT** be used solely to determine hose size. All "Beadlock-style" fittings shown in this catalog are designed to be coupled to barrier two braid dimension hose **ONLY**. Hose sizes also are known by the 6, 8, 10, 12 number designations. The chart below shows hose I.D.'s and their corresponding size number.

HOSE I.D. HOSE SIZE

5/16"	6
13/32"	8
1/2"	10
5/8"	12

Our Air Conditioning Line includes couplings for all standard thread ends, including steel couplings for heavy duty applications and hose which safely handles R12, R134a and R22 gases. A new, portable crimper allows the user to make high-quality assemblies with a minimal investment. Assemblies can also be made with coupling die sets and several standard hydraulic crimpers. Recommended for car and light truck automotive air conditioning and for tractors, construction trucks, mobile and stationary refrigeration units.

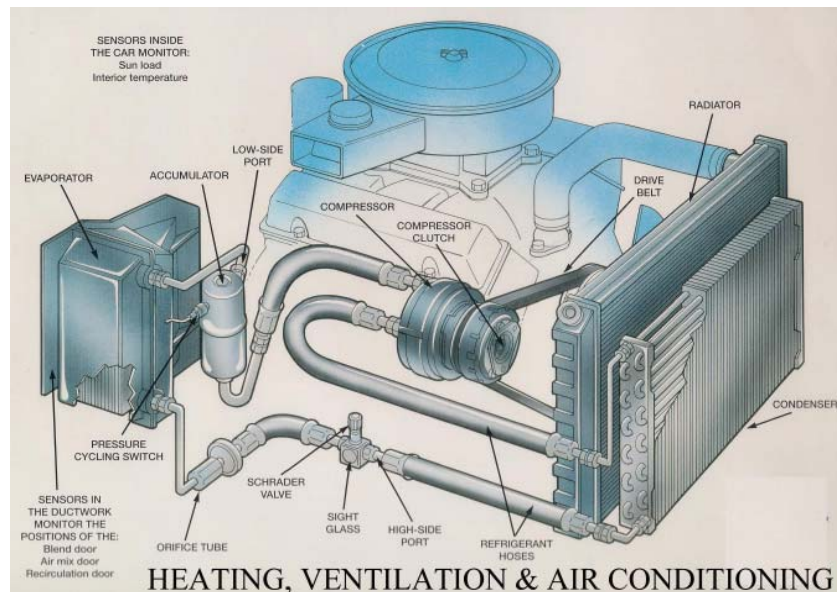

AIR CONDITIONING HOSE AND FITTING INFORMATION

AIR CONDITIONING

THREADED FITTING SIZE CHART - ALL FITTINGS ACTUAL SIZE (#14, #16 not shown)

FEMALE FLARE (no o'ring used)

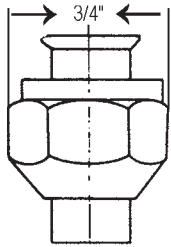

No. 6
5/8" - 18 Thread

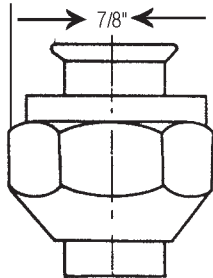

No. 8
3/4" - 16 Thread

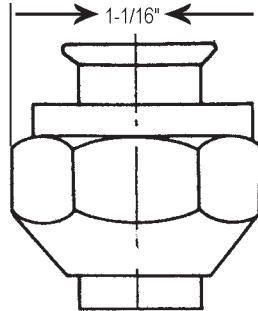

No. 10
7/8" - 14 Thread

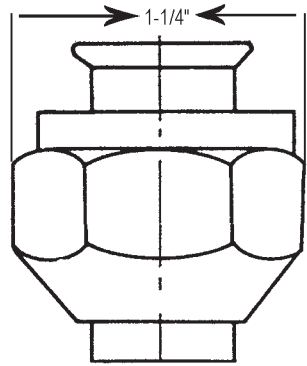

No. 12
1-1/16" - 14 Thread

MALE INSERT O'RING (o'ring located on inside)

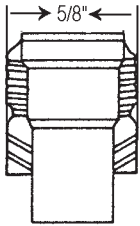

No. 6
5/8" - 18 Thread

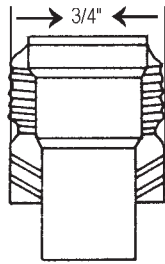

No. 8
3/4" - 16 Thread

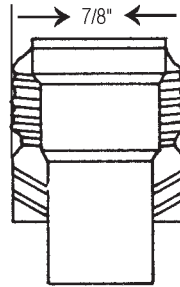

No. 10
7/8" - 14 Thread

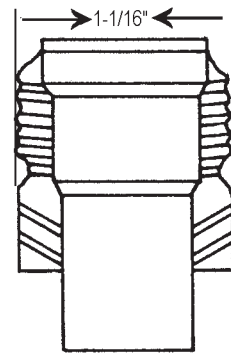

No. 12
1-1/16" - 14 Thread

MALE O'RING (o'ring located on outside)

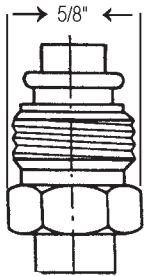

No. 6
5/8" - 18 Thread

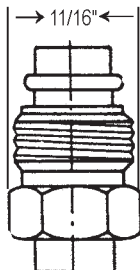

No. 7
SPECIAL GM/IHC
DRIER FITTING
11/16" - 16 Threads

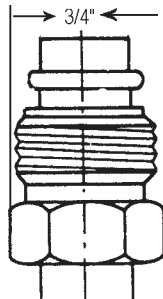

No. 8
3/4" - 18 Thread

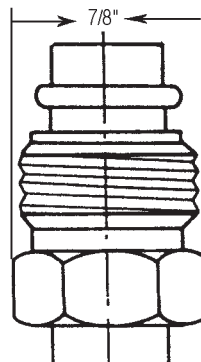

No. 10
7/8" - 18 Thread

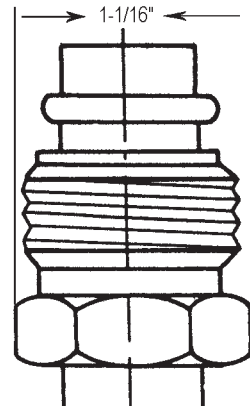

No. 12
1-1/16" - 16 Thread

FEMALE O'RING (o'ring located on outside)

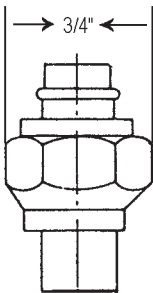

No. 6
5/8" - 18 Thread

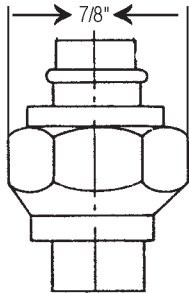

No. 8
3/4" - 16 Thread

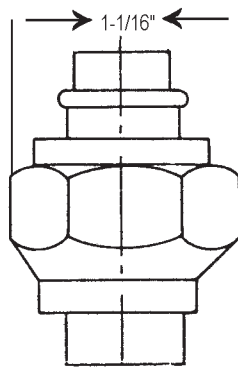

No. 10
7/8" - 14 Thread

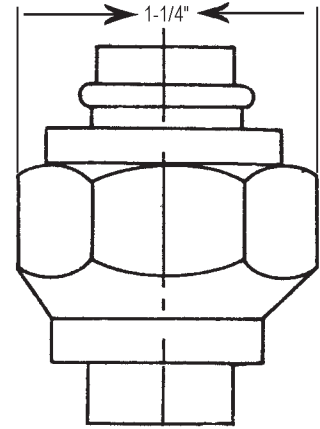

No. 12
1-1/16" - 14 Thread

AIR CONDITIONING ASSORTMENT

AIR CONDITIONING

A/C Hose and Fitting Kit

AC-KIT

Air Conditioning kit with hoses

This Assortment features:

442 items

Fittings for - Cars, light trucks, heavy trucks and off-road equipment.

Plus 90 feet of Hose

A/C-BANNER

BRAZE-PRACTICE-KIT

ONE LABEL SET

(Cabinets & Crimper not included)

PART #	DESCRIPTION	QTY
AC2901STEEL	Compression No Port 3/8 X 3/8	2
AC2902STEEL	Compression No Port 1/2 X 1/2	6
AC1102STEEL	Female Flare No Port 1/2 X 1/2	4
AC1103STEEL	Female Flare No Port 5/8 X 5/8	2
AC1311STEEL	Female Oring 45 3/8 X 3/8	2
AC1312STEEL	Female Oring 45 1/2 X 1/2	2
AC1322STEEL	Female Oring 90 No Port 1/2 X 1/2	10
AC1321STEEL	Female Oring 90 No Port 3/8 X 3/8	10
AC1323STEEL	Female Oring 90 No Port 5/8 X 5/8	6
AC1327STEEL	Female Oring 90 No Port 5/8 X 3/4	2
AC1322-3STEEL	Female Oring 90 W/Port 1/2 X 1/2	4
AC1323-3STEEL	Female Oring 90 W/Port 5/8 X 5/8	4
AC1301STEEL	Female Oring No Port 3/8 X 3/8	6
AC1302STEEL	Female Oring No Port 1/2 X 1/2	10
AC9305	Female Oring No Port 1/2 X M20	2
AC1303STEEL	Female Oring No Port 5/8 X 5/8	4
AC1401STEEL	Male Oring 3/8 X 3/8	2
AC1403STEEL	Male Oring 5/8 X 5/8	2
AC6601	Splicer Tip Aluminum 3/8	8
AC6602	Splicer Tip Aluminum 1/2	16
AC6603	Splicer Tip Aluminum 5/8	12
AC6605	Splicer Tip Aluminum 5/8 X 3/4	6
AC6604	Splicer Tip Aluminum 3/4	6
AC6601STEEL	Splicer Tip Steel 3/8	12
AC6602STEEL	Splicer Tip Steel 1/2	16
AC6603STEEL	Splicer Tip Steel 5/8	12
AC6605STEEL	Splicer Tip Steel 5/8 X 3/4	6
AC6604STEEL	Splicer Tip Steel 3/4	10
81-290	Schrader Valve Remover Universal	1
91-290	Schrader Valve Remover Large Bore	1
AC4150	Valve Core Hi Flow	10
AC4025	Valve Core Standard Flow	10
AFC1000	18" Aluminum Brazing Rod	25
BQ33RB	Pre-fluxed Silver Brazing Rods (8 pk)	1
AC4043	#10 Green 134A Oring	20
AC4044	#12 Green 134A Oring	20
AC4041	#6 Green 134A Oring	20
AC4042	#8 Green 134A Oring	20
FMF06-25	#6 Ferrule	10
FMF08-25	#8 Ferrule	10
FMF10-25	#10 Ferrule	10
FMF12-25	#12 Ferrule	10
AC-6	3/8" AC Hose R134A	25
AC-8	1/2" AC Hose R134A	25
AC-10	5/8" AC Hose R134A	25
AC-12	3/4" AC Hose R134A	15

AIR CONDITIONING CRIMPING SYSTEM



RB&H #
71-500

The “Hydra-Krimp” makes crimping barbed and bead fittings easy. The lightweight heand-held hydraulic press is very portable and ideal for shop and field applications. The kit comes with a complete set of dies covering hose sizes #6, #8, #10, #12 and reduced barrier #6, #8, #10, #12. The dies snap quickly into the press fixture requiring no pins or screws. A custom molded case is included in the kit.



Replacement Crimp Dies

	Standard	Die Carrier	Reduced Diameter	Die Carrier
#6	4986	4986C purple	4990	4990C black
#8	4987	4987C red	4986 (uses std # 6 die)	
#10	4988	4988C yellow	4991	4991C orange
#12	4989	4989C green	4992	4992C blue

AIR CONDITIONING HOSE

AIR CONDITIONING

Air Conditioning Hose

Goodyear Galaxy G4826 - Recommended for R134a and R12 refrigerants in automotive, heavy-duty truck, construction and agricultural air conditioning systems. Meets or exceeds the performance requirements of SAEJ2064, Type C Class II.



TUBE: Black synthetic rubber (Chloroprene - Type A).

BARRIER: Nylon

REINFORCEMENT: Two layers of spiral polyester.

COVER: Black synthetic rubber (EPDM).

TEMPERATURE RANGE: -22°F to +257°F (-30°C to +125°C).

RB&H #	HOSE I.D. (IN.)	HOSE O.D. (MAX.)	SPECIFICATIONS			
			MAX. WORKING	MIN. BURST	WEIGHT PER (FT.)	REEL LENGTH (FT.)
AC-6	5/16	.75	500	2,000	.20	340
AC-8	13/32	.91	500	2,000	.28	235
AC-10	1/2	1.00	500	2,000	.33	210
AC-12	5/8	1.13	350	1,750	.38	175

BEADLOCK FITTINGS

Ferrules



RB&H #	SPECIFICATIONS
	HOSE SIZE
FMF06-25	6
FMF08-25	8
FMF10-25	10
FMF12-25	12

Green Orings

for R12 and R134a Hose



RB&H #	SPECIFICATIONS	
	DIA. (IN)	THICKNESS (IN)
AC4041	.301	.70
AC4042	.426	.70
AC4043	.551	.70
AC4044	.676	.70
AC4046	.364	.70

BEADLOCK FITTINGS

AIR CONDITIONING

Beadlock Fittings (Hose Ends)

Straight Female Flare SAE 45° (FSX)



RB&H #	THREAD (IN.)	SPECIFICATIONS	
		FITTING SIZE	HOSE SIZE
AC1101STEEL	5/8 - 18	6	6
AC1102STEEL	3/4 - 16	8	8
AC1103STEEL	7/8 - 14	10	10

90° Female Flare SAE 45° (FSX90)



RB&H #	THREAD (IN.)	SPECIFICATIONS	
		FITTING SIZE	HOSE SIZE
AC1121STEEL	5/8 - 18	6	6
AC1122STEEL	3/4 - 16	8	8
AC1123STEEL	7/8 - 14	10	10

Straight Male Insert Oring



RB&H #	THREAD (IN.)	SPECIFICATIONS	
		FITTING SIZE	HOSE SIZE
AC1801STEEL	5/8 - 18	6	6
AC1802STEEL	3/4 - 16	8	8
AC1803STEEL	7/8 - 14	10	10
AC1804STEEL	1 1/16 - 14	12	12

90° Male Insert Oring



RB&H #	THREAD (IN.)	SPECIFICATIONS	
		FITTING SIZE	HOSE SIZE
AC1821STEEL	5/8 - 18	6	6
AC1822STEEL	3/4 - 16	8	8

Male Insert Oring Bulkhead Straight



RB&H #	THREAD (IN.)	SPECIFICATIONS	
		FITTING SIZE	HOSE SIZE
AC1701STEEL	5/8 - 18	6	6

Straight Female O-Ring (FTON)



RB&H #	THREAD (IN.)	SPECIFICATIONS	
		FITTING SIZE	HOSE SIZE
AC1301STEEL	5/8 - 18	6	6
AC1305STEEL	5/8 - 18	6	8
AC1302STEEL	3/4 - 16	8	8
AC9305	M20 - 1.5	M20	8
AC1306STEEL	3/4 - 16	8	10
AC1303STEEL	7/8 - 14	10	10
AC1307STEEL	7/8 - 14	10	12
AC1304STEEL	1 1/16 - 14	12	12

BEADLOCK FITTINGS

AIR CONDITIONING

Beadlock Fittings (Hose Ends)

Straight Female O-Ring (FTON) with Service Port

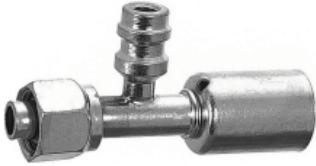

RB&H #	THREAD (IN.)	SPECIFICATIONS	
		FITTING SIZE	HOSE SIZE
AC1302-3STEEL	3/4 - 16	8	8
AC1303-3STEEL	7/8 - 14	10	10
AC1307-3STEEL	7/8 - 14	10	12

45° Female O-Ring (FTON45)



RB&H #	THREAD (IN.)	SPECIFICATIONS	
		FITTING SIZE	HOSE SIZE
AC1311STEEL	5/8 - 18	6	6
AC1312STEEL	3/4 - 16	8	8
AC1316STEEL	7/8 - 14	8	10
AC1313STEEL	7/8 - 14	10	10
AC1317STEEL	7/8 - 14	10	12
AC1314STEEL	1 1/16 - 14	12	12

45° Female O-Ring (FTON45) with Service Port



RB&H #	THREAD (IN.)	SPECIFICATIONS	
		FITTING SIZE	HOSE SIZE
AC1311-3STEEL	5/8 - 18	6	6
AC1312-3STEEL	3/4 - 16	8	8
AC1313-3STEEL	7/8 - 14	10	10
AC1317-3STEEL	7/8 - 14	10	12

90° Female O-Ring (FTON90)



RB&H #	THREAD (IN.)	SPECIFICATIONS	
		FITTING SIZE	HOSE SIZE
AC1321STEEL	5/8 - 18	6	6
AC1325STEEL	5/8 - 18	6	8
AC1328STEEL	3/4 - 16	8	6
AC1322STEEL	3/4 - 16	8	8
AC1326STEEL	3/4 - 16	8	10
AC1323STEEL	7/8 - 14	10	10
AC1327STEEL	7/8 - 14	10	12
AC1324STEEL	1 1/16 - 14	12	12

BEADLOCK FITTINGS

AIR CONDITIONING

Beadlock Fittings (Hose Ends)

90° Female O-Ring (FTON90) with R12 Service Port



RB&H #	THREAD (IN.)	SPECIFICATIONS	
		FITTING SIZE	HOSE SIZE
AC1322-1STEEL	3/4 - 16	8	8

90° Female O-Ring (FTON90) with R134a Service Port



RB&H #	THREAD (IN.)	SPECIFICATIONS	
		FITTING SIZE	HOSE SIZE
AC1321-3STEEL	5/8 - 18	6	6
AC1322-3STEEL	3/4 - 16	8	8
AC1323-3STEEL	7/8 - 14	10	10
AC1327-3STEEL	7/8 - 14	10	12

Straight Male O-Ring (MTON)



RB&H #	THREAD (IN.)	SPECIFICATIONS	
		FITTING SIZE	HOSE SIZE
AC1952STEEL	11/16	7	6
AC1401STEEL	5/8 - 18	6	6
AC1402STEEL	3/4 - 18	8	8
AC1403STEEL	7/8 - 18	10	10

45° Male O-Ring (MTON45)



RB&H #	THREAD (IN.)	SPECIFICATIONS	
		FITTING SIZE	HOSE SIZE
AC1411STEEL	5/8 - 18	6	6
AC1412STEEL	3/4 - 18	8	8
AC1413STEEL	7/8 - 18	10	10
AC1414STEEL	1 1/16 - 16	12	12

90° Male O-Ring (MTON90)



RB&H #	THREAD (IN.)	SPECIFICATIONS	
		FITTING SIZE	HOSE SIZE
AC1421STEEL	5/8 - 18	6	6
AC1425STEEL	5/8 - 18	6	8
AC1422STEEL	3/4 - 18	8	8
AC1423STEEL	7/8 - 18	10	10
AC1427STEEL	7/8 - 18	10	12
AC1424STEEL	1 1/16 - 16	12	12

**BEADLOCK FITTINGS
AIR CONDITIONING**

Beadlock Fittings (Hose Ends)

Splicer Straight (SP)



RB&H #	SPECIFICATIONS	
	HOSE END	HOSE END
AC6101STEEL	6	6
AC6105STEEL	6	8
AC6102STEEL	8	8
AC6106STEEL	8	10
AC6103STEEL	10	10
AC6107STEEL	10	12
AC6104STEEL	12	12

Splicer Straight with R12 Service Port



RB&H #	SPECIFICATIONS	
	HOSE END	HOSE END
AC6101-1STEEL	6	6
AC6102-1STEEL	8	8
AC6103-1STEEL	10	10

Splicer Straight with R134a Service Port (High Side)



RB&H #	SPECIFICATIONS	
	HOSE END	HOSE END
AC6101-3STEEL	6	6
AC6102-3STEEL	8	8

Splicer Straight with R134a Service Port (Low Side)



RB&H #	SPECIFICATIONS	
	HOSE END	HOSE END
AC6103-3STEEL	10	10
AC6104-3STEEL	12	12

Splicer Tee - 3 way



RB&H #	SPECIFICATIONS		
	HOSE END	HOSE END	HOSE END
AC6201STEEL	6	6	6
AC6202STEEL	8	8	8
AC6203STEEL	10	10	10
AC6204STEEL	12	12	12

**BEADLOCK FITTINGS
AIR CONDITIONING**

Beadlock Fittings (Hose Ends)

90° Female Tube-O Short Drop with R134a Service Port High Side



RB&H #	THREAD (IN.)	SPECIFICATIONS		
		FITTING SIZE	HOSE SIZE	"D" DROP LENGTH (IN.)
AC2142-3STEEL	1-14	FTO	8	0.78

90° Female Tube-O Short Drop with R134a Service Port Low Side



RB&H #	THREAD (IN.)	SPECIFICATIONS		
		FITTING SIZE	HOSE SIZE	"D" DROP LENGTH (IN.)
AC2143-3STEEL	1-14	FTO	10	0.78
AC2144-3STEEL	1-14	FTO	12	0.78

90° Female Tube-O with R134a Service Port High Side



RB&H #	THREAD (IN.)	SPECIFICATIONS		
		FITTING SIZE	HOSE SIZE	"D" DROP LENGTH (IN.)
AC2122-3STEEL	1-14	FRL	8	0.78

90° Female Tube-O with R134a Service Port Low Side



RB&H #	THREAD (IN.)	SPECIFICATIONS		
		FITTING SIZE	HOSE SIZE	"D" DROP LENGTH (IN.)
AC2132-3STEEL	1-14	FRL	10	0.78

Straight Compression Fitting Repairs Tubing (MFA)



RB&H #	THREAD (IN.)	SPECIFICATIONS	
		FITTING SIZE	HOSE SIZE
AC2901STEEL	5/8 - 18	3/8	6
AC2905STEEL	5/8 - 18	3/8	8
AC2908STEEL	3/4 - 16	1/2	6
AC2902STEEL	3/4 - 16	1/2	8
AC2906STEEL	3/4 - 16	1/2	10
AC2909STEEL	7/8 - 14	5/8	8
AC2903STEEL	7/8 - 14	5/8	10
AC2907STEEL	7/8 - 14	5/8	12
AC2904STEEL	1 1/16 - 14	3/4	12

BEADLOCK FITTINGS

AIR CONDITIONING

Beadlock Fittings (Hose Ends)

Outer Lip Beadlock Splicer Tip



RB&H #	SPECIFICATIONS	
	HOSE END	FITTING END
AC6601STEEL	6	6
AC6602STEEL	8	8
AC6603STEEL	10	10
AC6604STEEL	12	12
AC6605STEEL	12	10

SHOP SUPPLIES

Brazing Rod

Aluminum



RB&H #	SPECIFICATIONS	
	Length	
AFC1000	18"	

Pre-Flux Cored Silver



RB&H #	SPECIFICATIONS	
	Length	Diameter
BQ33RB	18"	.062

Shrader Valve Remover

Large Bore



RB&H #
91-290

Universal



RB&H #
81-290

Valve Core

Hi Flow



RB&H #
AC4150

Standard Flow



RB&H #
AC4025