

Thread Identification

ITEM	PAGE #
Couplings	
Coupling Selection	486
Ferrule Selection	486
Stem Selection	486
Coupling Dash Size and End Style	487
Thread End Catalog Descriptions	487
Coupling Identification	487
North American	
North American Thread Types	487
Iron Pipe Thread Abbreviations	487
NPSM	487
NPTF	487
NPSF	487
37° Flare (JIC)	488
SAE (45° Flare)	488
O-Ring Boss	488
O-Ring Flange (SAE J518)	489
O-Ring Flat-Face Seal	489
Ermetto Flareless Tube	489
SAE Inverted Flare	490
Female Braze-On Stems.....	490
Grease Fittings	490
Special Male Grease Fitting	490
Special Female Grease Fitting.....	490
Foreign Thread Types	
British	
British Standard Pipe Parallel	491
British Standard Pipe Tapered	491
French	
GAZ 24°	492
GAZ Poclairn 24° Flange	492
German DIN	493
DIN 24° Cone	493
DIN 60° Cone	493
DIN 3852 Couplings Type A & B	494
DIN 3852 Type C Metric and Whitworth Tapered Thread Connections.....	495
Metric Standpipe Assembly	495
Japanese	
Japanese 30° Flare Parallel Threads	496
Japanese Tapered Pipe Threads	496
Komatsu Style 30° Flare Parallel Threads	497
Komatsu Style Flange Fitting	497
Application Data	
Brass Fitting & Steel Adapters Identification	
Fitting Thread Size Comparison Chart	498
Tube Fittings.....	498
Pipe Fittings	498
Compression Fittings	499
Polyline® Flareless	500
Push to Connect	500
Gates Hose Selection Chart	501
Weatherhead Hose Selection Chart.....	501
Synflex Hose Selection Chart.....	502

THREAD IDENTIFICATION

COUPLINGS

Coupling Selection

A Gates hydraulic hose coupling usually consists of two primary components:

1. A Ferrule placed over the end of a hose
2. A Stem inserted into the end of a hose

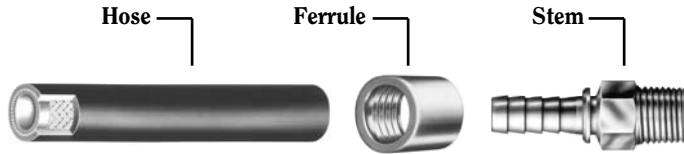

Ferrule Selection

Ferrule type designations (PC, PCS, PCM, C4, etc.) correspond to the stem hose and type designations (16PCS-16MP, etc.).

Always consult Gates Crimp Data Charts for correct ferrule recommendations. For example, C12M hose can be coupled with either PCS1F or PCS2F ferrules and PCS stems. PCS1F ferrules require no skiving. You simply crimp the coupling to the hose.

The number “2” before the “F” in ferrule designations means that two steps are needed for correct hose coupling:

1. Skiving to remove the cover from the hose end
2. Crimping phase

Always install the correct ferrule for a specific hose and stem combination. For instance, there is an important design difference between an 8PC2F-2 ferrule and an 8PC2F-2C ferrule which is vital to the compatibility and performance of the hose assembly.

Always refer to Gates Crimp Data Charts for the right hose, stem and ferrule combination.

Example of ferrule description:

6PC1FS

6	PC	1	F	S
Dash Size	Stem Type	No-Skive (2=Skive)	Ferrule	Material (S=Steel) (A=Aluminum)

Stem Selection

Different hoses may require different coupling styles. To make your selection, determine the correct stem to be used. There are two functional ends of the stem to consider:

1. The hose end for hose attachment
2. The thread end for port attachment

References to the coupling type(s) recommended for a specific hose are listed on the individual hose data pages; for example, C13 (G5K) hose specifies GlobalSpiral™ and PCM couplings.

The thread end of a coupling (or adapter) can be identified by comparing with the coupling being replaced or by measuring the port or thread end to which it is to be attached.

See the thread end identification nomenclature listed in table below.

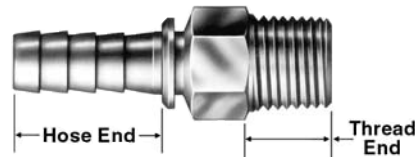

COUPLING & ADAPTER END STYLE CODE

CODE	DESCRIPTION	CODE	DESCRIPTION	CODE	DESCRIPTION
B	O-Ring Boss	FL	Code 61 O-Ring Flange	MN	Metric Male
BJ	Banjo	FLC	Caterpillar Style O-Ring Flange (Code 62)	MPG	Male Special Grease Fitting
BKHD	Bulkhead	FLH	Code 62 O-Ring Flange Heavy	MSP	Metric Stand Pipe
BS	Bite Sleeve	FT	Female SAE Tube	OR	O-Ring
BSPP	British Standard Parallel Pipe	HLE	Hose Length Extender	P	Pipe Thread (NPTF or NPSM)
C	Caterpillar Flange Dimension	HLEC	Hose Length Extender (Caterpillar)	PL	Press Lok®
CC	Clamping Collar	HM	Hose Mender	R	Reusable
DH	DIN Heavy	I	Inverted Flare	S	SAE (45° Flare)
DL	DIN Light	J	JIC (37° Flare)	X	Swivel
F	Female	JIS	Japanese Industrial Standard	Z	Parker Triple Thread
FBO	Female Braze-on Stem	K	Komatsu Style (Japanese 30° Seat)	22	22 1/2°
FF	Flat-Face	LH	Long Hex	30	30°
FFN	Female Flareless Nut	LN	Long Nose	45	45°
FFOR	Flat-Face O-Ring	M	Male	60	60°
FFS	Female Flareless Sleeve	MFA	Male Flareless Assembly (Ermeto)	67	67 1/2°
FG	Female Grease Thread	MKB	Metric Kobelco	90	90°
FKX	Female Komatsu Style Swivel	MM	Metric Male	110	110°

THREAD IDENTIFICATION

COUPLINGS

Coupling Dash Size and End Style

Coupling Dash Size is a shorthand method of denoting the size of a particular end fitting. See table to left.

THREAD SIZE DASH NUMBERS			
DASH SIZE	THREAD SIZES		
	NPTF-NPSM	SAE (45° FLARE)	JIC (37° FLARE) SAE "O-RING" BOSS
2	1/2 - 27	-	-
3	-	-	3/8 - 24
4	1/4 - 18	7/16 - 20	7/16 - 20
5	-	1/2 - 20	1/2 - 20
6	3/8 - 18	5/8 - 18	9/16 - 18
8	1/2 - 14	3/4 - 16	3/4 - 16
10	-	7/8 - 14	7/8 - 14
12	3/4 - 14	1 1/16 - 14	1 1/16 - 12
14	-	-	1 3/16 - 12
16	1 - 11 1/2	-	1 5/16 - 12
20	1 1/4 - 11 1/2	-	1 5/8 - 12
24	1 1/2 - 11 1/2	-	1 7/8 - 12
32	2 - 11 1/2	-	2 1/2 - 12

"O-Ring" Flange dash numbers are determined by nominal flange size, or diameter of flange head which determines the "O-Ring" size.

EXAMPLES:

12MP denotes a 3/4" male pipe thread end fitting. The corresponding thread description for a 3/4" pipe thread is 3/4 - 14 NPTF solid male.

12FJX denotes a 3/4" female JIC swivel (37° seat) end fitting. The corresponding thread description or a 3/4" JIC thread is 1 1/16"-12 JIC 37° flare swivel female.

12FL denotes a 3/4" SAE standard pressure (Code 61) flange fitting. This is the standard fitting description for a 3/4" SAE standard pressure flange.

Thread End Catalog Descriptions

Gates coupling ends shown below are accepted as industry standards. See detailed catalog listings for availability of specific hose/coupling combinations, detailed descriptions, thread end configurations such as swivels and bent tubes and special ends.

Thread End Identification Tools (See Page 468)

Coupling Identification

There are five coupling systems generally used for hydraulic connections today. They are identified geographically or by country as: North American / British / French / German / Japanese. The sections that follow list the origin and coupling style found in each country. Brief descriptions and dimensional data follows each coupling style.

NORTH AMERICAN

North American Thread Types

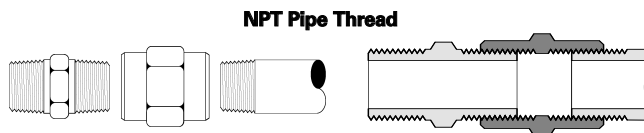

NPT Pipe Thread

Iron Pipe Thread Abbreviations

N National	F Fuels
P Pipe	S Straight Thread
T Tapered Thread	M Mechanical Joint

SPECIFICATIONS

DASH SIZE	NOMINAL SIZE (IN.)	# OF THREADS PER (IN.)	THREAD SIZES	
			FEMALE THREAD I.D. (IN.)	MALE THREAD O.D. (IN.)
-2	1/8	27	23/64	13/32
-4	1/4	18	15/32	35/64
-6	3/8	18	19/32	43/64
-8	1/2	14	3/4	27/32
-12	3/4	14	61/64	1 1/16
-16	1	11 1/2	1 19/64	1 9/16
-20	1 1/4	11 1/2	1 17/32	1 43/64
-24	1 1/2	11 1/2	1 25/32	1 29/64
-32	2	11 1/2	2 1/4	2 3/8

NPTF

This is a dryseal thread; the National pipe tapered thread for fuels. This is used for both male and female ends.

The NPTF male will mate with the NPTF, NPSF, or NPSM female.

The NPTF male has tapered threads and a 30° inverted seat.

The NPTF female has tapered threads and no seat. The seal takes place by deformation of the threads. The NPSM female has straight threads and a 30° inverted seat. The seal takes place on the 30° seat.

The NPTF connector is similar to, but not interchangeable with, the BSPT connector. The thread pitch is different in most sizes. Also, the thread angle is 60° instead of the 55° angle found on BSPT threads.

NPSM

National pipe straight thread for mechanical joint. This is used on the female swivel nut of iron pipe swivel adapters. The leak-resistant joint is not made by the sealing fit of threads, but by a tapered seat in the coupling end.

NPSF

The National pipe straight thread for fuels. This is sometimes used for female ends and properly mates with the NPTF male end. However, the SAE recommends the NPTF thread is preference to the NPSF for female ends.

THREAD IDENTIFICATION

NORTH AMERICAN

37° Flare (JIC)*

The Society of Automotive Engineers (SAE) specifies a 37° angle flare or seat be used with high pressure hydraulic tubing.

These are commonly called JIC couplings.

The JIC 37° flare male will mate with a JIC female only.

The JIC male has straight threads and a 37° flare seat.

The JIC female has straight threads and a 37° flare seat.

The seal is made on the 37° flare seat.

Some sizes have the same threads as the SAE 45° flare. Carefully measure the seat angle to differentiate.

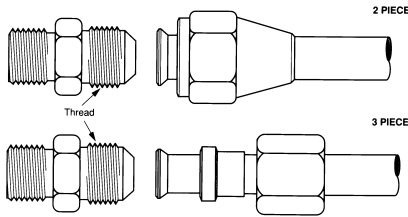

* Some C5, C5E and Lock-On couplings may have dual machined seats (both 37° and 45° seats).

DASH SIZE	NOMINAL SIZE (IN.)	THREAD SIZE (IN.)	THREAD SIZES	
			FEMALE THREAD I.D. (IN.)	MALE THREAD O.D. (IN.)
-2	1/8	5/16 - 24	17/64	5/16
-3	3/16	3/8 - 24	21/64	3/8
-4	1/4	7/16 - 20	25/64	7/16
-5	5/16	1/2 - 20	29/64	1/2
-6	3/8	9/16 - 18	1/2	9/16
-8	1/2	3/4 - 16	11/16	3/4
-10	5/8	7/8 - 14	13/16	7/8
-12	3/4	1 1/16 - 12	31/32	1 1/16
-14	7/8	1 3/16 - 12	1 7/64	1 3/16
-16	1	1 5/16 - 12	1 15/64	1 5/16
-20	1 1/4	1 5/8 - 12	1 35/64	1 5/8
-24	1 1/2	1 7/8 - 12	1 51/64	1 7/8
-32	2	2 1/2 - 12	2 27/64	2 1/2

SAE (45° Flare)*

A term usually applied to fittings having a 45° angle flare or seat.

Soft copper tubing is generally used in such applications as it is easily flared to the 45° angle.

These are for low pressure applications, such as for fuel lines and refrigerant lines.

The SAE 45° flare male will mate with an SAE 45° flare female only.

The SAE male has straight threads and a 45° flare seat.

The SAE female has straight threads and a 45° flare seat.

The seal is made on the 45° flare seat.

Some sizes have the same threads as the SAE 37° flare. Carefully measure the seat angle to differentiate.

Special Power Steering Thread End

DASH SIZE	NOMINAL SIZE (IN.)	THREAD SIZE (IN.)	THREAD SIZES	
			FEMALE THREAD I.D. (IN.)	MALE THREAD O.D. (IN.)
3/8	1 1/16	1 1/16 - 18	5/8	1 1/16

* Some C5, C5E PCTS, C14 and Lock-On couplings may have dual machined seats (both 37° and 45° seats).

DASH SIZE	NOMINAL SIZE (IN.)	THREAD SIZE (IN.)	THREAD SIZES	
			FEMALE THREAD I.D. (IN.)	MALE THREAD O.D. (IN.)
-2	1/8	5/16 - 24	17/64	5/16
-3	3/16	3/8 - 24	21/64	3/8
-4	1/4	7/16 - 20	25/64	7/16
-5	5/16	1/2 - 20	29/64	1/2
-6	3/8	5/8 - 18	9/16	5/8
-7	7/16	1 1/16 - 16	5/8	1 1/16
-8	1/2	3/4 - 16	11/16	3/4
-10	5/8	7/8 - 14	13/16	7/8
-12	3/4	1 1/16 - 14	63/64	1 1/16
-14	7/8	1 1/4 - 12	1 11/64	1 1/4
-16	1	1 3/8 - 12	1 19/64	1 3/8

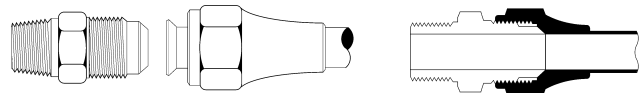

O-Ring Boss

The O-Ring boss male will mate with an O-Ring boss female only. The female is generally found on ports.

The male has straight threads and an O-Ring. The female has straight threads and a sealing face. The seal is made at the O-Ring on the male and the sealing face on the female.

SAE Straight Thread O-Ring Boss

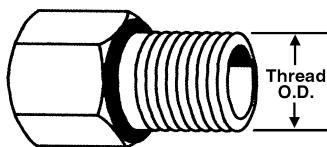

DASH SIZE	NOMINAL SIZE (IN.)	THREAD SIZE (IN.)	THREAD SIZES		O-RING SIZE
			FEMALE THREAD I.D. (IN.)	MALE THREAD O.D. (IN.)	
-2	1/8	5/16 - 24	17/64	5/16	20R
-3	3/16	3/8 - 24	21/64	3/8	30R
-4	1/4	7/16 - 20	25/64	7/16	40R
-5	5/16	1/2 - 20	29/64	1/2	50R
-6	3/8	9/16 - 18	1/2	9/16	60R
-8	1/2	3/4 - 16	11/16	3/4	80R
-10	5/8	7/8 - 14	13/16	7/8	100R
-12	3/4	1 1/16 - 12	31/32	1 1/16	120R
-14	7/8	1 3/16 - 12	1 7/64	1 3/16	140R
-16	1	1 5/16 - 12	1 15/64	1 5/16	160R
-20	1 1/4	1 5/8 - 12	1 35/64	1 5/8	200R
-24	1 1/2	1 7/8 - 12	1 51/64	1 7/8	240R
-32	2	2 1/2 - 12	2 27/64	2 1/2	320R

THREAD IDENTIFICATION

NORTH AMERICAN

SAE Code 61 and Code 62

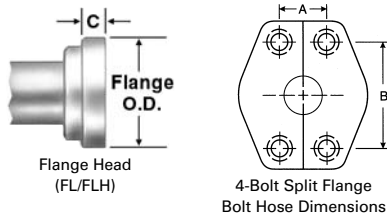

O-Ring Flange (SAE J518)

The SAE Code 61 and Code 62 4-Bolt Split Flange is used worldwide, usually as a connection on pumps and motors.

There are three exceptions:

1. The -10 size, which is common outside of North America, is not an SAE standard size.
2. Caterpillar flanges, which are the same flange O.D. as SAE Code 62, have a thicker flange head ("C" dimension in Table).
3. Poclairn flanges, which are completely different from SAE flanges.

SPECIFICATIONS

NOMINAL FLANGE SIZE (IN.)	CODE 61 (FL)			CODE 62 (FLH)			CATERPILLAR (FLC)					
	FLANGE O.D. (IN.)	"A" (IN.)	"B" (IN.)	"C" (IN.)	FLANGE O.D. (IN.)	"A" (IN.)	"B" (IN.)	"C" (IN.)	FLANGE O.D. (IN.)	"A" (IN.)	"B" (IN.)	"C" (IN.)
1/2	1.188	0.688	1.500	.265	1.250	0.718	1.594	.305	-	-	-	-
5/8	1.338	-	-	.265	-	-	-	-	-	-	-	-
3/4	1.500	0.875	1.875	.265	1.625	0.937	2.000	.345	1.625	0.938	2.000	.560
1	1.750	1.031	2.062	.315	1.875	1.093	2.250	.375	1.875	1.094	2.250	.560
1 1/4	2.000	1.188	2.312	.315	2.125	1.250	2.625	.405	2.125	1.250	2.625	.560
1 1/2	2.375	1.406	2.750	.315	2.500	1.437	3.125	.495	2.500	1.438	3.125	.560
2	2.812	1.688	3.062	.375	3.125	1.750	3.812	.495	3.125	1.750	3.812	.560
2 1/2	3.312	2.000	3.500	.375	-	-	-	-	-	-	-	-
3	4.000	2.438	4.188	.375	-	-	-	-	-	-	-	-
3 1/2	4.500	2.750	4.750	.422	-	-	-	-	-	-	-	-
4	5.000	3.062	5.125	.442	-	-	-	-	-	-	-	-
5	6.000	3.625	6.000	.442	-	-	-	-	-	-	-	-

SPECIFICATIONS

DASH SIZE	NOMINAL SIZE (IN.)	THREAD SIZE (IN.)	THREAD SIZES		O-RING SIZE
			FEMALE THREAD I.D. (IN.)	MALE THREAD O.D. (IN.)	
-4	1/4	9/16 - 18	1/2	9/16	-011
-6	3/8	1 1/16 - 16	5/8	1 1/16	-012
-8	1/2	1 3/16 - 16	3/4	1 3/16	-014
-10	5/8	1 - 14	15/16	1	-016
-12	3/4	1 3/16 - 12	1 1/8	1 3/16	-018
-16	1	1 7/16 - 12	1 11/32	1 7/16	-021
-20	1 1/4	1 11/16 - 12	1 19/32	1 11/16	-025
-24	1 1/2	2 - 12	1 29/32	2	-029

O-Ring Flat-Face Seal (ORFS) J1453

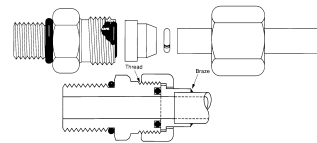

A seal is made when the O-Ring in the male contacts the flat face on the female. Couplings are intended for hydraulic systems where elastomeric seals are acceptable to overcome leakage and leak resistance is crucial. The solid male O-Ring face seal fitting will mate with a swivel female O-Ring face seal fitting only. An O-Ring rests in the O-Ring groove in the male.

SPECIFICATIONS

DASH SIZE	TUBE SIZE (IN.)	NOMINAL SIZE (IN.)	THREAD SIZE (IN.)	THREAD SIZES	
				FEMALE THREAD I.D. (IN.)	MALE THREAD O.D. (IN.)
-2	1/8	5/16	5/16 - 24	17/64	5/16
-3	3/16	3/8	3/8 - 24	21/64	3/8
-4	1/4	7/16	7/16 - 20	25/64	7/16
-5	5/16	1/2	1/2 - 20	29/64	1/2
-6	3/8	9/16	9/16 - 18	1/2	9/16
-8	1/2	3/4	3/4 - 16	1 1/16	3/4
-10	5/8	7/8	7/8 - 14	1 3/16	7/8
-12	3/4	1 1/16	1 1/16 - 12	31/32	1 1/16
-14	7/8	1 3/16	1 3/16 - 12	1 7/64	1 3/16
-16	1	1 5/16	1 5/16 - 12	1 15/64	1 5/16
-20	1 1/4	1 5/8	1 5/8 - 12	1 35/64	1 5/8
-24	1 1/2	1 7/8	1 7/8 - 12	1 51/64	1 7/8
-32	2	2 1/2	2 1/2 - 12	2 27/64	2 1/2

Ermetto Flareless Tube

The flareless solid male will mate with a female flareless nut and compression sleeve only.

The male has straight threads and a 24° seat. The female has straight threads and has a compression sleeve for a sealing surface. The seal is made between the compression sleeve and the 24° seat on the male, and between the compression sleeve and the tubing on the female.

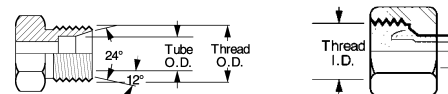

SIMILAR TO: Weatherhead 7000 series Parker ferrule lock

THREAD IDENTIFICATION

NORTH AMERICAN

SAE Inverted Flare

The SAE 45° inverted flare male will mate with an SAE 42° inverted flare female only.

The male has straight threads and a 45° inverted flare. The female has straight threads and a 42° inverted flare. The seal is made on the 45° flare seat on the male and the 42° flare seat on the female.

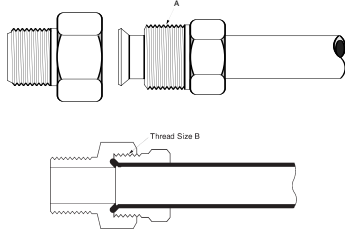

SPECIFICATIONS

DASH SIZE	NOMINAL SIZE (IN.)	THREAD SIZE (IN.)	THREAD SIZES	
			FEMALE THREAD I.D. (IN.)	MALE THREAD O.D. (IN.)
-2	1/8	5/16 - 28	9/32	5/16
-3	3/16	3/8 - 24	21/64	3/8
-4	1/4	7/16 - 24	25/64	7/16
-5	5/16	1/2 - 20	29/64	1/2
-6	3/8	5/8 - 18	37/64	5/8
-7	7/16	11/16 - 18	5/8	11/16
-8	1/2	3/4 - 16	45/64	3/4
-10	5/8	7/8 - 18	13/16	7/8
-12	3/4	1 1/16 - 16	1	1 1/16

Female Braze-On Stems

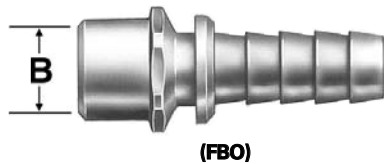

SPECIFICATIONS

DASH SIZE	TUBING O.D. "B" (IN.)
-4	1/4
-5	5/16
-6	3/8
-8	1/2
-10	5/8
-12	3/4
-16	1
-20	1 1/4
-24	1 1/2

NOTE: Can be brazed or welded to an existing thread end

Grease Fittings

Special Male Grease Fitting



1/8-27 Pipe Thread
(3-2MPG)

Special Female Grease Fitting

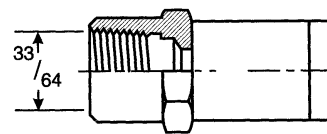

1/2-27 Tapered Thread
(4-8FG)

THREAD IDENTIFICATION

FOREIGN THREAD TYPES

British

It is a common misconception that all foreign threads are metric. This is not always the case. There are two common thread forms: metric and Whitworth (BSP). The country of origin and the proper nomenclature for each is listed below.

SPECIFICATIONS				
DASH SIZE	NOMINAL SIZE (IN.)	THREAD SIZE (IN.)	THREAD SIZES	
			FEMALE THREAD I.D. (IN.)	MALE THREAD O.D. (IN.)
-2	1/8	1/8 - 28	11/32	3/8
-4	1/4	1/4 - 19	15/32	17/32
-6	3/8	3/8 - 19	19/32	21/32
-8	1/2	1/2 - 14	3/4	13/16
-10	5/8	5/8 - 14	13/16	29/32
-12	3/4	3/4 - 14	31/32	1 1/32
-16	1	1 - 11	1 7/32	1 11/32
-20	1 1/4	1 1/4 - 11	1 17/32	1 21/32
-24	1 1/2	1 1/2 - 11	1 25/32	1 7/8
-32	2	2 - 11	2 7/32	1 11/32

British Standard Pipe Parallel

Popular couplings have British Standard Pipe (BSP) threads, also known as Whitworth threads. These can be parallel (BSPP) or tapered (BSPT), with a 30° inverted flare. Flanges are equivalent to SAE Code 61 or Code 62 (except -10*). Port connections are usually made with BSPP threads and a soft metal cutting ring for sealing. The BSPP (parallel) male will mate with a BSPP (parallel) female or a female port. The BSPP male has straight threads and a 30° seat. The BSPP female has straight threads and a 30° seat. The female port has straight threads and a spotface. The seal on the port is made with an O-Ring or soft metal washer on the male or both.

The BSPP (parallel) connector is similar to, but not interchangeable with, the NPSM connector. The thread pitch is different in most sizes, and the thread angle is 55° instead of the 60° angle found on NPSM threads.

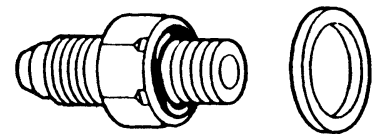

SPECIFICATIONS				
DASH SIZE	NOMINAL SIZE (IN.)	THREAD SIZE (IN.)	THREAD SIZES	
			FEMALE THREAD I.D. (IN.)	MALE THREAD O.D. (IN.)
-2	1/8	1/8 - 28	11/32	3/8
-4	1/4	1/4 - 19	15/32	17/32
-6	3/8	3/8 - 19	19/32	21/32
-8	1/2	1/2 - 14	3/4	13/16
-10	5/8	5/8 - 14	13/16	29/32
-12	3/4	3/4 - 14	31/32	1 1/32
-16	1	1 - 11	1 7/32	1 11/32
-20	1 1/4	1 1/4 - 11	1 17/32	1 21/32
-24	1 1/2	1 1/2 - 11	1 25/32	1 7/8
-32	2	2 - 11	2 7/32	1 11/32

British Standard Pipe Tapered

The BSPT (tapered) male will mate with a BSPT (tapered) female, or a BSPP (parallel) female.

The BSPT male has tapered threads. When mating with either the BSPT (tapered) female or the BSPP (parallel) female port, the seal is made on the threads.

The BSPT connector is similar to, but not interchangeable with, the NPTF connector. The thread pitch is different in most cases, and the thread angle is 55° instead of the 60° angle found on NPTF threads.

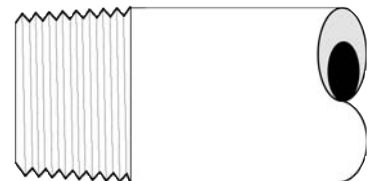

THREAD IDENTIFICATION

FOREIGN THREAD TYPES

French

Popular couplings are French GAZ. These have a 24° seat and metric threads. These are similar to German DIN couplings, but the threads are different in some sizes. Although both are metric threads, the French use fine threads in all sizes and German DIN couplings use coarse threads in larger sizes. French tube O.D.'s are fractional millimeters. Most port connections are flange connections. French flanges are different than SAE, they have a lip that protrudes from the flange face. These are called Poclairn style flanges.

GAZ 24°

The French Metric (GAZ) male will mate with the female 24° cone or the female tube fitting.
 The male has a 24° seat and straight metric threads. The female has a 24° seat or a tubing sleeve and straight metric threads.
 When measuring the flare angle with the seat angle gauge, use the 12° gauge. (The seat angle gauge measures the angle from the connector centerline).

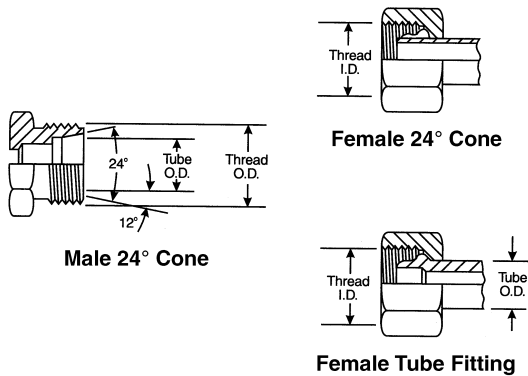

METRIC THREAD SIZE	THREAD SIZES		TUBE O.D. (MM)
	FEMALE I.D. (MM)	MALE O.D. (MM)	
M20X1.5	18.5	20.0	13.25
M24X1.5	22.5	24.0	16.75
M30X1.5	28.5	30.0	21.25
M36X1.5	34.5	36.0	26.75
M45X1.5	43.5	45.0	33.50
M52X1.5	50.5	52.0	42.25

GAZ Poclairn 24° Flange

The Poclairn (French GAZ) 24° high pressure flange is usually found on Poclairn equipment.
 The male flange will mate with a female flange or a port. The seal is made on the 24° seat.

NOMINAL SIZE (IN.)	SPECIFICATIONS					
	"A" (IN.)	"B" (IN.)	"C" (IN.)	"D" (IN.)	"E" (IN.)	"F" (IN.)
1/2	1.57	.72	2.20	1.89	.55	.35
5/8	1.57	.72	2.20	1.89	.55	.35
3/4	2.00	.94	2.75	2.38	.71	.43

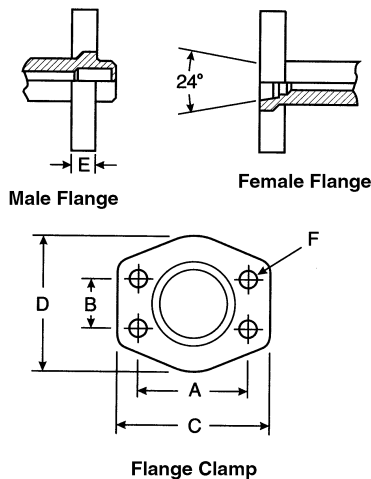

THREAD IDENTIFICATION

FOREIGN THREAD TYPES

SPECIFICATIONS

METRIC THREAD SIZE	THREAD SIZES		TUBE O.D.	
	FEMALE I.D. (MM)	MALE O.D. (MM)	LIGHT (L) SERIES (MM)	HEAVY (S) SERIES (MM)
M12X1.5	10.5	12.0	6	—
M14X1.5	12.5	14.0	8	—
M16X1.5	14.5	16.0	10	8
M18X1.5	16.5	18.0	12	10
M20X1.5	18.5	20.0	14	12
M22X1.5	20.5	22.0	15	14
M24X1.5	22.5	24.0	—	16
M26X1.5	24.5	26.0	18	—
M30X2.0	28.0	30.0	22	20
M36X2.0	34.0	36.0	28	25
M42X2.0	40.0	42.0	—	30
M45X2.0	43.0	45.0	35	—
M52X2.0	50.0	52.0	42	38

German DIN

DEUTSCHE INDUSTRIAL NORME

Popular couplings are German DIN (Deutsche Industrial Norme).
A coupling referred to as metric, usually means a DIN coupling.
Flanges are standard Code 61 or Code 62 (except -10)*.

DIN 24° Cone

The DIN 24° cone male will mate with any of the three females shown.

The male has a 24° seat, straight metric threads, and a recessed counterbore which matches the tube O.D. of the coupling used with it. The mating female is a 24° cone with O-Ring, a metric tube fitting or a universal 24° or 60° cone.

There is a light and heavy series DIN coupling. Proper identification is made by measuring both the thread size and the tube O.D. (The heavy series has a smaller tube O.D. than the light, but has a thicker wall section.)

When measuring the flare angle with the seat angle gauge, use the 12° gauge. (The seat angle gauge measuring the angle from the connector centerline.)

The nuts used with steel tubing will generally have an 'S', 'L', or 'LL' stamped on the rear of the hex to indicate the Heavy, Light, or Extra Light series. (Extra Light is available on special order in sizes — 8, 10, 12mm tube O.D.)

DIN 24° Male and Mating Females

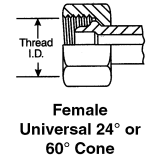
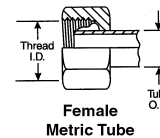
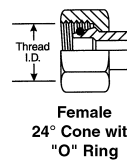
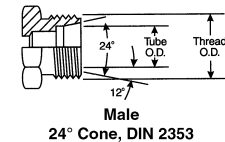

SPECIFICATIONS

METRIC THREAD SIZE	THREAD SIZES		TUBE O.D. (MM)
	FEMALE I.D. (MM)	MALE O.D. (MM)	
M12X1.5	10.5	12.0	6
M14X1.5	12.5	12.5	8
M16X1.5	14.5	14.5	10
M18X1.5	16.5	16.5	12
M20X1.5	18.5	18.5	14
M22X1.5	20.5	20.5	15
M24X1.5	22.5	22.5	—
M26X1.5	24.5	24.5	18
M30X2.0	28.0	28.0	22

DIN 60° Cone

The DIN 60° cone male will mate with the female universal 24° or 60° cone connector only.

The male has a 60° seat and straight metric threads. The female has a 24° and 60° universal seat and straight metric threads.

When measuring the flare angle with the seat angle gauge, use the 30° gauge. (The seat angle gauge measures the angle from the connector centerline.)

DIN 60° Male and Mating Female

THREAD IDENTIFICATION

FOREIGN THREAD TYPES

DIN 3852 Couplings Type A & B

PARALLEL THREADS

The male DIN 3852 Type A & B couplings will mate with the female DIN coupling shown below.

The male and female type A & B couplings have straight threads.

Table 1 refers to straight metric threads, and Table 2 refers to straight Whitworth threads. The seal occurs when the ring seal (Type A) or the face seal (Type B) mates with the face of the female port.

There are two series of DIN 3852 Type A & B couplings, the light (L) and the heavy (S) series.

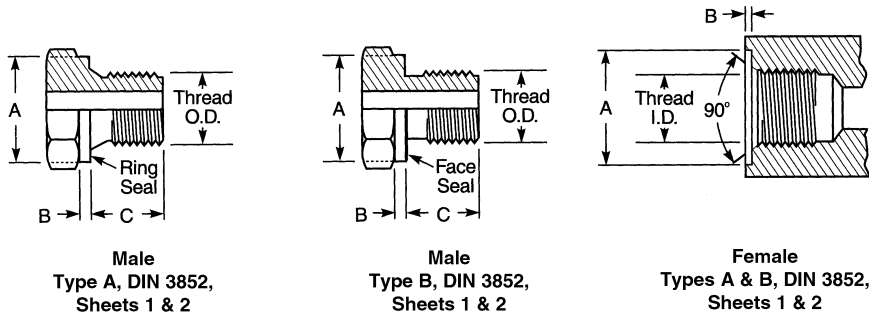

Male
Type A, DIN 3852,
Sheets 1 & 2

Male
Type B, DIN 3852,
Sheets 1 & 2

Female
Types A & B, DIN 3852,
Sheets 1 & 2

SPECIFICATIONS

SERIES	TUBE O.D. (MM)	MALE TABLE 1					MALE TABLE 2					FEMALE TABLE 1				FEMALE TABLE 2				
		MALE METRIC THREAD PARALLEL DIN 3852 TYPE A & B						MALE WHITWORTH THREAD PARALLEL DIN 3852 TYPE A & B					FEMALE METRIC THREAD PARALLEL DIN 3852 TYPE A & B				FEMALE WHITWORTH THREAD PARALLEL DIN 3852 TYPE A & B			
		METRIC THREAD SIZE (MM)	THREAD O.D. (MM)	"A" (MM)	"B" (MM)	"C" (MM)	WHITWORTH THREAD SIZE (IN.)	THREAD O.D. (IN.)	"A" (MM)	"B" (MM)	"C" (MM)	METRIC THREAD SIZE (MM)	THREAD I.D. (MM)	"A" (MM)	"B" (MM)	WHITWORTH THREAD SIZE (IN.)	THREAD O.D. (IN.)	"A" (MM)	"B" (MM)	
(L)	6	10X1	10	14	1.5	8	1/8 - 28	3/8	14	1.5	8	10X1	8.5	15	1.0	1/8 - 28	1 1/32	15	1.0	
Light	8	12X1.5	12	17	2.0	12	1/4 - 19	1/2	17	2.0	12	12X1.5	10.5	18	1.5	1/4 - 19	15/32	19	1.5	
"	10	14X1.5	14	19	2.0	12	1/4 - 19	1/2	19	2.0	12	14X1.5	12.5	20	1.5	1/4 - 19	15/32	19	1.5	
"	12	16X1.5	16	21	2.5	12	3/8 - 19	2 1/32	21	2.5	12	16X1.5	14.5	22	1.5	3/8 - 19	19/32	23	2.0	
"	15	18X1.5	18	23	2.5	12	1/2 - 14	1 9/16	23	2.5	12	18X1.5	16.5	24	2.0	1/2 - 14	3/4	27	2.5	
"	18	22X1.5	22	27	3.0	14	1/2 - 14	1 9/16	27	3.0	14	22X1.5	20.5	28	2.5	1/2 - 14	3/4	27	2.5	
"	22	26X1.5	26	31	3.0	16	3/4 - 14	1 1/32	31	3.0	16	26X1.5	24.5	32	2.5	3/4 - 14	3 1/32	33	2.5	
"	28	33X2	33	39	3.0	18	1 - 11	1 5/16	39	3.0	18	33X2	31.5	40	2.5	1 - 11	1 7/32	40	2.5	
"	35	42X2	42	49	3.0	20	1 1/4 - 11	1 2 1/32	49	3.0	20	42X2	40.5	50	2.5	1 1/4 - 11	1 17/32	50	2.5	
"	42	48X2	48	55	3.0	22	1 1/2 - 11	1 7/8	55	3.0	22	48X2	46.5	56	2.5	1 1/2 - 11	1 25/32	56	2.5	
(S)	6	12X1.5	12	17	2.0	12	1/4 - 19	1/2	17	2.0	12	12X1.5	10.5	18	1.5	1/4 - 19	15/32	19	1.5	
Heavy	8	14X1.5	14	19	2.0	12	1/4 - 19	1/2	19	2.0	12	14X1.5	12.5	20	1.5	1/4 - 19	15/32	19	1.5	
"	10	16X1.5	16	21	2.5	12	3/8 - 19	2 1/32	21	2.5	12	16X1.5	14.5	22	1.5	3/8 - 19	19/32	23	2.0	
"	12	18X1.5	18	23	2.5	12	3/8 - 19	2 1/32	23	2.5	12	18X1.5	16.5	24	2.0	3/8 - 19	19/32	23	2.0	
"	14	20X1.5	20	25	3.0	14	1/2 - 14	1 9/16	25	3.0	14	20X1.5	18.5	26	2.0	1/2 - 14	3/4	27	2.5	
"	16	22X1.5	22	27	3.0	14	1/2 - 14	1 9/16	27	3.0	14	22X1.5	20.5	28	2.5	1/2 - 14	3/4	27	2.5	
"	20	27X2	27	32	3.0	16	3/4 - 14	1 1/32	32	3.0	16	27X2	25.5	33	2.5	3/4 - 14	3 1/32	33	2.5	
"	25	33X2	33	39	3.0	18	1 - 11	1 5/16	39	3.0	18	33X2	31.5	40	2.5	1 - 11	1 7/32	40	2.5	
"	30	42X2	42	49	3.0	20	1 1/4 - 11	1 2 1/32	49	3.0	20	42X2	40.5	50	2.5	1 1/4 - 11	1 17/32	50	2.5	
"	38	48X2	48	55	3.0	22	1 1/2 - 11	1 7/8	55	3.0	22	48X2	46.5	56	2.5	1 1/2 - 11	1 25/32	56	2.5	

THREAD IDENTIFICATION

FOREIGN THREAD TYPES

DIN 3852 Type C Metric and Whitworth Tapered Thread Connections

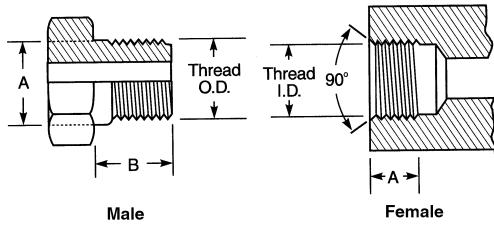

The DIN 3852 Type C couplings are available with either metric or Whitworth British thread. The male will mate only with the female as shown.

The male and female couplings have tapered threads. Table 1 refers to tapered metric threads, and Table 2 refers to tapered Whitworth threads. The seal takes place on the threads.

There are three series of DIN 3852 Type C couplings: extra light (LL), light (L) and heavy (S).

SPECIFICATIONS

SERIES	TUBE O.D. (MM)	MALE TABLE 1				MALE TABLE 2				FEMALE TABLE 1			FEMALE TABLE 2		
		MALE DIN 3852 TYPE C METRIC TAPERED THREADS				MALE DIN 3852 TYPE C WHITWORTH TAPERED THREADS				FEMALE DIN 3852 TYPE C METRIC TAPERED THREAD			FEMALE DIN 3852 TYPE C WHITWORTH TAPERED THREADS		
		METRIC THREAD SIZE (MM)	"A" (MM)	"B" (MM)	THREAD O.D. (MM)	WHITWORTH THREAD SIZE (IN.)	"A" (MM)	"B" (MM)	THREAD O.D. (IN.)	METRIC THREAD SIZE (MM)	THREAD I.D. (MM)	"A" (MM)	WHITWORTH THREAD SIZE (IN.)	THREAD I.D. (IN.)	"A" (MM)
(LL)	4	8X1	8.40	8	8	1/8 - 28	.392	8	1/8	8X1	6.5	5.5	1/8 - 28	11/32	5.5
Extra	5	8X1	8.40	8	8	1/8 - 28	.392	8	1/8	8X1	6.5	5.5	1/8 - 28	11/32	5.5
Light	6	10X1	10.40	8	10	1/8 - 28	.392	8	1/8	10X1	8.5	5.5	1/8 - 28	11/32	5.5
	8	10X1	10.40	8	10	1/8 - 28	.392	8	1/8	10X1	8.5	5.5	1/8 - 28	11/32	5.5
(L)	6	10X1	10.40	8	10	1/8 - 28	.392	8	1/8	10X1	8.5	5.5	1/8 - 28	11/32	5.5
Light	8	12X1.5	12.53	12	12	1/4 - 19	.532	12	1/4	12X1.5	10.5	8.5	1/4 - 19	15/32	8.5
	10	14X1.5	14.53	12	14	1/4 - 19	.532	12	1/4	14X1.5	12.5	8.5	1/4 - 19	15/32	8.5
	12	16X1.5	16.53	12	16	3/8 - 19	.670	12	3/8	16X1.5	14.5	8.5	3/8 - 19	19/32	8.5
	15	18X1.5	18.53	12	18	1/2 - 14	.839	14	1/2	18X1.5	16.5	8.5	1/2 - 14	3/4	8.5
	18	22X1.5	22.65	14	22	1/2 - 14	.839	14	1/2	22X1.5	20.5	10.5	1/2 - 14	3/4	10.5
(S)	6	12X1.5	12.53	12	12	1/4 - 19	.532	12	1/4	12X1.5	10.5	8.5	1/4 - 19	15/32	8.5
Heavy	8	14X1.5	14.53	12	14	1/4 - 19	.532	12	1/4	14X1.5	12.5	8.5	1/4 - 19	15/32	8.5
	10	16X1.5	16.53	12	16	3/8 - 19	.670	12	3/8	16X1.5	14.5	8.5	3/8 - 19	19/32	8.5
	12	18X1.5	18.53	12	18	3/8 - 19	.670	12	3/8	18X1.5	16.5	8.5	3/8 - 19	19/32	8.5
	14	20X1.5	20.65	14	20	1/2 - 14	.839	14	1/2	20X1.5	18.5	10.5	1/2 - 14	3/4	10.5
	16	22X1.5	22.65	14	22	1/2 - 14	.839	14	1/2	22X1.5	20.5	10.5	1/2 - 14	3/4	10.5

SPECIFICATIONS

METRIC STANDPIPE DIN TUBE O.D. (MM)	BITE SLEEVE DIN TUBE O.D. (MM)	METRIC NUT THREAD	
		LIGHT	HEAVY
6	6	M12X1.5	-
8	8	M14X1.5	M16X1.5
10	10	M16X1.5	M18X1.5
12	12	M18X1.5	M20X1.5
15	15	M22X1.5	-
16	16	-	M24X1.5
18	18	M26X1.5	-
20	20	-	M30X2
22	22	M30X2	-
25	25	-	M36X2
28	28	M36X2	-
30	30	-	M42X2
35	35	M45X2	-
38	38	-	M52X2
42	42	M52X2	-

Metric Standpipe Assembly

A metric standpipe assembly is comprised of three components attached to a male fitting. The components are: a Standpipe, Bite Sleeve and Metric Nut. The nut is placed over the Standpipe, followed by the Bite Sleeve (see illustration below). For DIN light assemblies, a DIN light metric nut is used. For DIN heavy assemblies, a DIN heavy metric nut is used. The Bite Sleeve and Standpipe are selected on the basis of tube O.D. required.

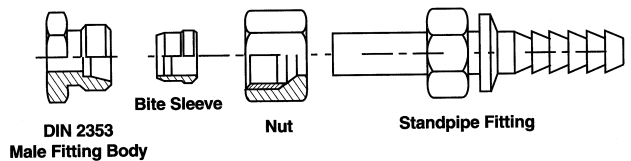

THREAD IDENTIFICATION

FOREIGN THREAD TYPES

Japanese

There are two popular coupling styles in Japan:

1. All Komatsu equipment uses couplings with a 30° seat and metric fine threads. All flanges are Code 61 or Code 62 (except -10)*.
2. Most other Japanese equipment uses couplings with a 30° seat and British Standard Pipe Parallel threads, usually called JIS (Japanese Industrial Standard) couplings. They are not interchangeable with British couplings, since the flare is not inverted. All flanges are Code 61 or Code 62 (except -10)*.
3. Popular on Mitsubishi equipment.

Japanese 30° Flare Parallel Threads

These Japanese 30° flare male connector will mate with a Japanese 30° flare female only.

The male and female have straight threads and a 30° seat. The seal is made on the 30° seat.

The threads on the Japanese 30° flare connector conform to JIS B 0202, which are the same as the BSPP threads. Both the British and Japanese connectors have a 30° seat, but they are not interchangeable, because the British seat is inverted.

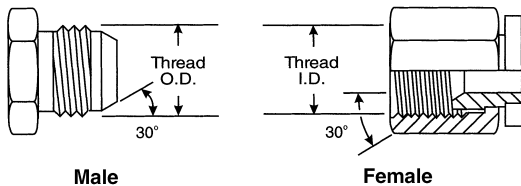

DASH SIZE	NOMINAL SIZE (IN.)	THREAD SIZE (IN.)	THREAD SIZES	
			FEMALE THREAD I.D. (IN.)	MALE THREAD O.D. (IN.)
-2	1/8	1/8 - 28	1 1/32	3/8
-4	1/4	1/4 - 19	7/16	17/32
-6	3/8	3/8 - 19	19/32	21/32
-8	1/2	1/2 - 14	3/4	13/16
-10	5/8	5/8 - 14	13/16	29/32
-12	3/4	3/4 - 14	15/16	1 1/32
-16	1	1 - 11	1 3/16	1 5/16
-20	1 1/4	1 1/4 - 11	1 17/32	1 21/32
-24	1 1/2	1 1/2 - 11	1 25/32	1 7/8
-32	2	2 - 11	2 7/32	1 11/32

Japanese Tapered Pipe Threads

The Japanese tapered pipe thread connector is identical to and fully interchangeable with the BSPT (tapered) connector. The Japanese connector does not have a 30° Flare, and will not mate with the BSPP female.

The threads conform to JIS B 0203, which are the same as BSPT threads.

The seal on the Japanese tapered pipe thread connector is made on the threads.

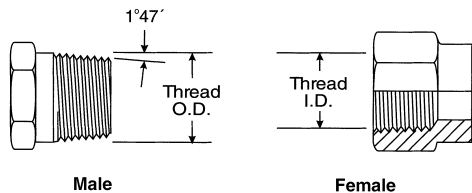

DASH SIZE	NOMINAL SIZE (IN.)	THREAD SIZE (IN.)	PARALLEL	
			FEMALE THREAD I.D. (IN.)	MALE THREAD O.D. (IN.)
-2	1/8	1/8 - 28	1 1/32	3/8
-4	1/4	1/4 - 19	7/16	17/32
-6	3/8	3/8 - 19	19/32	21/32
-8	1/2	1/2 - 14	3/4	13/16
-12	3/4	3/4 - 14	15/16	1 1/32
-16	1	1 - 11	1 3/16	1 5/16
-20	1 1/4	1 1/4 - 11	1 17/32	1 21/32
-24	1 1/2	1 1/2 - 11	1 25/32	1 7/8
-32	2	2 - 11	2 7/32	2 11/32

* (-10 is a non-SAE size flange)

THREAD IDENTIFICATION

FOREIGN THREAD TYPES

SPECIFICATIONS

DASH SIZE	NOMINAL SIZE		METRIC THREAD SIZE (IN.)	THREAD SIZES	
	(IN.)	(MM)		FEMALE THREAD I.D. (MM)	MALE THREAD O.D. (MM)
-6	3/8	9.5	M18X1.5	16.5	18
-8	1/2	13.0	M22X1.5	20.5	22
-10	5/8	16.0	M24X1.5	22.5	24
-12	3/4	19.0	M30X1.5	28.5	30
-16	1	25.0	M33X1.5	31.5	33
-20	1 1/4	32.0	M36X1.5	34.5	36
-24	1 1/2	38.0	M42X1.5	40.5	42

Komatsu Style 30° Flare

PARALLEL THREADS

The Komatsu Style 30° Flare parallel thread connector is identical to the Japanese 30° Flare parallel thread connector except for the threads. The Komatsu style connector uses Metric fine threads which conform to JIS B 0207.

The Komatsu style connector seals on the 30° Flare.

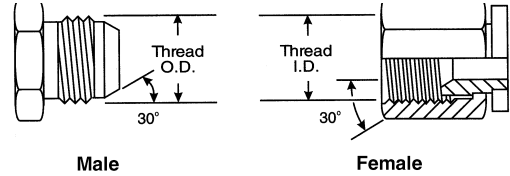

SPECIFICATIONS

DASH SIZE	NOMINAL SIZE		FLANGE O.D. (IN.)	"A" (IN.)	"B" (IN.)
	(IN.)	(MM)			
-8	1/2	12.7	1.188	0.728	0.984
-10*	5/8	15.9	1.345	0.728	1.102
-12	3/4	19.1	1.500	0.846	1.220
-16	1	25.4	1.750	1.122	1.496
-20	1 1/4	31.8	2.000	1.358	1.732
-24	1 1/2	38.1	2.375	1.750	2.125
-32	2	50.8	2.812	2.225	2.559

* (-10 is a non-SAE size flange)

Komatsu Style Flange Fitting

The Komatsu Style Flange fitting is nearly identical to and fully interchangeable with the SAE Code 61 flange fitting.

In all sizes the O-Ring dimensions are different. When replacing a Komatsu style flange with an SAE style flange, an SAE style O-Ring must always be used.

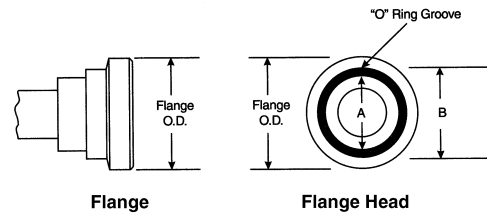

Brass Fitting & Steel Adapters Identification

Fitting Thread Size Comparison Chart

The male connections have (Male unified thread class 2 fit) UN-2A specification threads and the female connections have (Female unified thread class 2 fit) UN-2B specification threads.

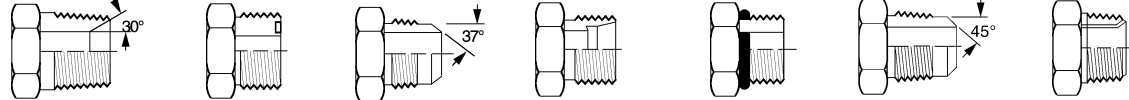

SIZE	PIPE SIZE	FLAT FACE O-RING	37° FLARE FLARE-TWIN®	ERMETO® 7000 SERIES	STRAIGHT THREAD O-RING BOSS	45° FLARE	INVERTED FLARE
1/8	1/8 - 27	—	5/16 - 24	5/16 - 24	5/16 - 24	5/16 - 24	5/16 - 28
3/16	—	—	3/8 - 24	3/8 - 24	3/8 - 24	3/8 - 24	3/8 - 24
1/4	1/4 - 18	9/16 - 18	7/16 - 20	7/16 - 20	7/16 - 20	7/16 - 20	7/16 - 24
5/16	—	—	1/2 - 20	1/2 - 20	1/2 - 20	1/2 - 20	1/2 - 20
3/8	3/8 - 18	1 1/16 - 16	9/16 - 18	9/16 - 18	9/16 - 18	5/8 - 18	5/8 - 18
7/16	—	—	—	—	—	1 1/16 - 16	1 1/16 - 18
1/2	1/2 - 14	1 3/16 - 16	3/4 - 16	3/4 - 16	3/4 - 16	3/4 - 16	3/4 - 18
5/8	—	1 - 14	7/8 - 14	7/8 - 14	7/8 - 14	7/8 - 14	7/8 - 18
3/4	3/4 - 14	1 3/16 - 12	1 1/16 - 12	1 1/16 - 12	1 1/16 - 12	1 1/16 - 14	1 1/16 - 16
7/8	—	1 3/16 - 12	1 3/16 - 12	1 3/16 - 12	1 3/16 - 12	—	1 3/16 - 16
1	1 - 11 1/2	1 7/16 - 12	1 5/16 - 12	1 5/16 - 12	1 5/16 - 12	—	1 5/16 - 16
1 1/4	1 1/4 - 11 1/2	1 11/16 - 12	1 5/8 - 12	1 5/8 - 12	1 5/8 - 12	—	—
1 1/2	1 1/2 - 11 1/2	2 - 12	1 7/8 - 12	1 7/8 - 12	1 7/8 - 12	—	—
2	2 - 11 1/2	—	2 1/2 - 12	2 1/2 - 12	2 1/2 - 12	—	—
2 1/2	2 1/2 - 8	—	3 - 12	—	—	—	—
3	3 - 8	—	3 1/2 - 12	—	—	—	—

Tube Fittings

There are four basic types of tube fittings: Flare, Flareless, Straight Thread O-Ring, and Flat Face O-Ring Seal. Tube fittings seal in two ways. Flare and Flareless fittings use metal to metal contact joints. Straight Thread O-Ring and Flat Face O-Ring fittings use a rubber O-Ring. Where extreme vibration is present, use Flareless, Straight Thread or Flat Face O-Ring Seal fittings.

SIZING: For accuracy, it is recommended the male thread be measured. Measure the outside diameter. For our example use 7/16". Next measure the threads per inch - use 20. Our fitting size measures 7/16 - 20. Refer to the thread chart on this page for appropriate tube size and illustration.

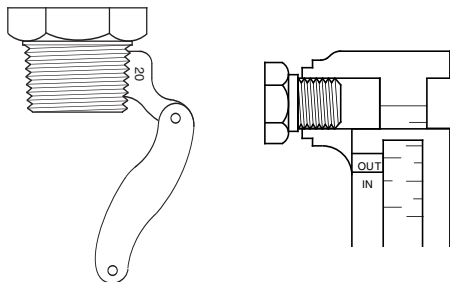

Pipe Fittings

The American Society of Automotive Engineers in cooperation with industry set up a standard for improvement in pipe threads. This improvement is known as the Dryseal Pipe Thread. All Weatherhead pipe threads are American Standard Taper Dryseal Pipe Threads (NPTF). The metal to metal seal is formed by contact at the thread crest and root.

Nominal pipe sizes do not agree with either the I.D., O.D., or thread sizes. To determine pipe sizes (up to 1 1/4") measure the diameter of the threads and subtract 1/4". For example, subtract 1/4" from a 1" pipe to obtain the nominal pipe size of 3/4".

Pipe sizes can also be given in 'dash numbers'. A dash number is always the numerator of an inch over 16ths. For instance, if the pipe O.D. measures 1/2", that would be converted to 16ths (8/16), but be written as -8.

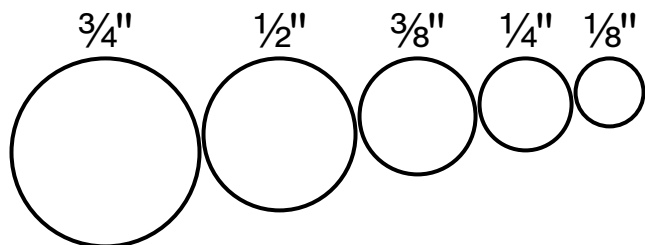

THREAD IDENTIFICATION

COMPRESSION FITTINGS

Compression Fittings

APPLICATION: Instrumentation, hydraulic and pneumatic systems.

PRESSURE: Working pressure up to 2000 psi with a 4:1 safety factor depending on tube size. When using plastic tubing, use the working pressure for type used.

VIBRATION: Fair resistance - use long nut when greater vibration resistance is needed.

TEMPERATURE RANGE: -65°F to +250°F (-53°C to +121°C) range at maximum operating pressures. (Refer to tubing temperature range.)

MATERIAL: CA360 Brass.

USED WITH: Aluminum, copper and plastic tubing. Not recommended for steel tubing.

ADVANTAGES: Low cost. Easy to assemble, no flaring. Available with long or short nut. Broad selection of styles and sizes.

CONFORMATION: Listed by Underwriter's Laboratories (available on special order) for flammable liquids. Meets specifications and standards of ASA, ASME and SAE.

HOW TO ORDER: Compression fittings are ordered as complete assemblies (body, nut and sleeve). To order assembly supplied with long nuts, simply add the prefix "1" to the catalog number.

Example: 68X4 with long nut becomes 168X4.

Assembly Instructions:

1. Cut tubing to desired length.
2. Slide nut and then sleeve on tube. Threaded end "A" of nut must face toward fitting.
3. Insert tubing into fitting body. Be sure tubing is bottomed on fitting shoulder.
4. Lubricate threads and assemble nut to fitting body.
5. Tighten nut hand tight. From that point, tighten with a wrench the number of turns indicated in the chart below.

SPECIFICATIONS

TUBE SIZE (IN.)	ADDITIONAL TURNS FROM HAND TIGHT
1/8 thru 1/4	1 - 1/4
5/16	1 - 3/4
3/8 thru 1	2 - 1/4

Label Set: W-8022

SPECIFICATIONS

TUBE O.D. (IN.)	THREAD SIZE-B (IN.)
1/8	5/16 - 24
3/16	3/8 - 24
1/4	7/16 - 24
5/16	1/2 - 24
3/8	9/16 - 24
7/16	5/8 - 24
1/2	1 1/16 - 20
5/8	1 3/16 - 18
3/4	1 - 18
1	1 1/4 - 18

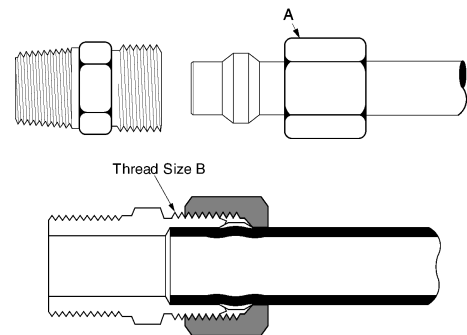

THREAD IDENTIFICATION

POLYLINE® FLARELESS

Polyline® Flareless

Assembly Instructions:

1. Cut tubing to desired length.
2. Slide nut and then sleeve on tube. Threaded end "A" of nut must face toward fitting.
3. Bottom tubing into fitting.
4. Plastic sleeve - tighten nut, hand tight.
5. Brass sleeve - tighten nut, hand tight, then additional ¼ turn.

Label Set: FS-2100

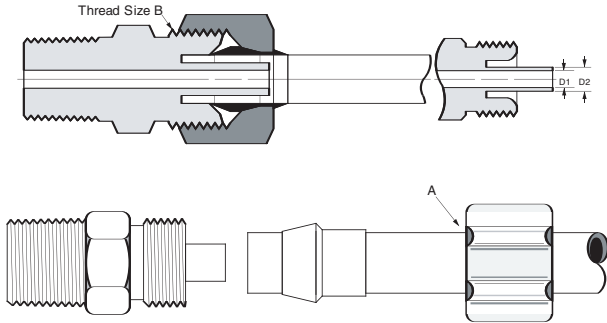

APPLICATION: Pneumatic instrumentation circuits, lubricant and cooling lines.

PRESSURE: Working pressure up to 500 psi with a 4:1 safety factor depending on tube size. When using plastic tubing, use the working pressure for type used.

VIBRATION: Excellent resistance.

TEMPERATURE RANGE: Depends on tubing used. -65°F to +250°F (-53°C to +121°C) with brass sleeve, -40°F to +150°F (-40°C to +66°C) with plastic sleeve. (Refer to tubing temperature range in tubing section.)

MATERIAL: CA360 brass body, plastic sleeve.

USED WITH: Aluminum, copper and hard plastic tubing requires brass sleeve. PT200 and PT240 plastic tubing and plastic sleeve. Not recommended for steel tubing.

ADVANTAGES: No flaring of tubing required. Easy installation, captive sleeve, preassembled for installation and can be reassembled.

CONFORMATION: An exclusive item with Weatherhead. User approvals only.

HOW TO ORDER: Order ¼" O.D. tubing with .040 wall, use suffix X4. Example: 1262X4. When .062 wall is desired, use suffix X46. Example: 1262X46.

NOTE: ⅛" and ⅜" tube O.D. assemblies are supplied with brass sleeves and no inserts.

SPECIFICATIONS

SIZE (IN.)	TUBE O.D. (IN.)	THREAD SIZE-B (IN.)	FLOW DIA (D1) (IN.)	SUPPORT DIA. (D2) (IN.)
X2	⅛	⅝ - 24	.094*	—
X3	⅜	⅝ - 24	.125*	—
X46	¼	⅝ - 24	.078	.120
X4	¼	⅝ - 24	.125	.166
X5	⅜	7/16 - 24	.141	.180
X6	⅝	½ - 24	.203	.245
X8	½	1 1/16 - 20	.312	.370

*No tube support in assembly - Flow Diameter for body only

PUSH TO CONNECT

Push to Connect

Assembly Instructions:

1. To connect, simply push the tubing into the fitting.
2. To disconnect, depress the collet ring with two fingers and withdraw.

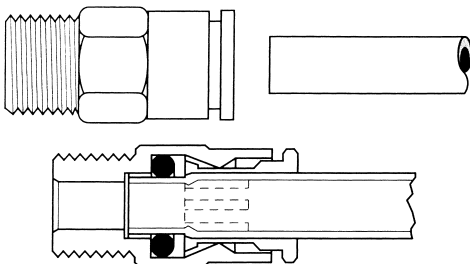

APPLICATION: Compressed air, pneumatic instrumentation, circuit, lubricant and cooling lines.

PRESSURE: Up to 250 psi depending on tube size.

SEALING METHOD: O-Ring of Buna-N construction.

TEMPERATURE RANGE: -40°F to +200°F (-40°C to +93°C.)

MATERIAL: Brass.

VACUUM: Fittings rated at 29.5 inches of Mercury vacuum.

USED WITH: PT230 and TP160 nylon, and PT240 Polyethylene tubing.

ADVANTAGES: Ease of assembly. No tools required, reusability of fittings and the time savings of assembly and disassembly.

HOW TO ORDER: Individually by catalog number.

THREAD IDENTIFICATION

GATES HOSE SELECTION CHART

Standard	Industry	Description	Construction (Reinforcement)	Use	Page #	Temp Range	Dash Size vs. Rated Workign Pressure (psi)																
							-2	-3	-4	-5	-6	-8	-10	-12	-16	-20	-24	-32	-40	-48	-56	-64	
SAE 100R15	EFG6K	4&6-spiral, wire	Extreme High Pressure, Petrol, Oils	21	-40 +250	0	0	0	0	6000	6000	6000	6000	6000	6000	6000	0	0	0	0	0	0	0
SAE 100R13	EFG5K	4&6-spiral, wire	Extreme High Pressure, Petrol, Oils	5, 21	-40 +250	0	0	0	0	5000	5000	5000	5000	5000	5000	5000	0	0	0	0	0	0	0
SAE 100R12	EFG4K	4&6-spiral, wire	Extreme High Pressure, Petrol, Oils	9	-40 +250	0	0	0	0	4000	4000	4000	4000	4000	4000	4000	0	0	0	0	0	0	0
SAE 100R15	G6K	4&6-spiral, wire	Extreme High Pressure	9	-40 +250	0	0	0	0	6000	6000	6000	6000	6000	6000	6000	0	0	0	0	0	0	0
SAE 100R13	G5K	4&6-spiral, wire	Extreme High Pressure Petrol, Oils	8, 21	-40 +250	0	0	0	0	5000	5000	5000	5000	5000	5000	5000	0	0	0	0	0	0	0
SAE 100R12	G4K	4-spiral, wire	Extreme High Pressure Petrol, Oils	9	-40 +250	0	0	0	0	0	0	4000	4000	4000	4000	4000	0	0	0	0	0	0	0
SAE 100R12	G3K	4-spiral, wire	Extreme High Pressure Petrol, Oils	9, 47	-40 +250	0	0	0	0	0	0	0	0	0	0	3000	3000	3000	0	0	0	0	0
SAE 100R12	C12	4-spiral, wire	High Pressure, Petrol, Oils	9, 47	-40 +250	0	0	0	0	0	0	0	0	0	0	2500	2500	0	0	0	0	0	0
SAE 100R12	C12M	4-spiral, wire	High Pressure, Tight Bends Petrol, Oils	9, 47	-40 +250	0	0	0	0	4000	4000	0	4000	4000	3000	0	0	0	0	0	0	0	0
SAE 100R2 Type AT	G2	2-braid, wire	Petroleum Oils	11	-40 +212	0	0	5800	0	4800	4000	3625	3100	2400	1825	1300	1175	0	0	0	0	0	0
SAE 100R2 Type AT	G2L	2-braid, wire	Petroleum Oils, Low Temp.	21	-70 +212	0	0	5800	0	4800	4000	3625	3100	2400	1825	1300	0	0	0	0	0	0	0
SAE 100R16	M2T*	2-braid, wire	Tight Bends, High Flexibility	11	-40 +212	0	0	5000	0	4000	3500	3000	2250	2000	0	0	0	0	0	0	0	0	0
Gates Proprietary	M2T*	2-braid, wire	Tight Bends, High Flexibility	11	-40 +212	0	0	5000	0	4000	3500	3000	2250	2000	0	0	0	0	0	0	0	0	0
SAE 100R17	M4K+	2-braid, wire	Tight Bends, High Flexibility	12	-40 +212	0	0	4000	0	4000	4000	4000	4000	0	0	0	0	0	0	0	0	0	0
SAE 100R17	M3K	1 & 2-braid, wire	Tight Bends, High Flexibility	13, 47	-40 +212	0	0	3000	3000	3000	3000	3000	3000	3000	0	0	0	0	0	0	0	0	0
SAE 100R2 Type AT	G2H	2-braid, wire	High Temp.	11	-40 +275	0	0	0	0	0	0	0	0	0	1650	1300	1175	0	0	0	0	0	0
SAE 100R1 Type AT	G2ATHMP	2-braid, wire	Multi-Fluid, High Temp.	11, 12	-40 +300	0	0	0	0	0	4250	3500	3000	0	0	0	0	0	0	0	0	0	0
SAE 100R1 Type AT	G1	1-braid, wire	Petroleum Oils	13	-40 +212	0	0	3275	3125	2600	2325	1900	1525	1275	925	725	600	0	0	0	0	0	0
SAE 100R3	G3H (C3/C3H)	2-braid, textile	Petrol.Oils, Antifreeze, Water, High Temp.	14	-40 +275			1,250		1,125	1,000		750	565	375								
SAE 100R6	GTH (C6H)	1-braid, textile	Petrol.Oils, Antifreeze, Water, High Temp.	21	-40 +275	0	0	400	400	400	400	350	300	0	0	0	0	0	0	0	0	0	0
SAE 100R4	G4H	2-spiral, textile	Return & Suction High Temp.	17, 21	-40 +275	0	0	0	0	0	0	0	300	212	200	0	0	0	0	0	0	0	0
SAE 100R4	GMV	2-spiral, textile	Return & Suction High Temp.	17, 21	-40 +275	0	0	0	0	0	0	0	350	300	250	162	112	68	62	56	56	56	56
SAE 30R2 Type 1 & 2	RLA	1-braid, textile	Return & Low Pressure	19, 21	-40 +212	0	0	250	250	250	200	200	200	160	0	0	0	0	0	0	0	0	0
	RLC	3-braid, textile	Return & Low Pressure	18, 21	-40 +275	0	0	0	0	0	0	0	0	200	200	200	200	150	150	150	0	0	0
	LOC	1-braid, textile	Petrol, Oils, Antifreeze, Water & Air	19, 21	-40 +212	0	0	300	0	300	300	300	300	0	0	0	0	0	0	0	0	0	0
	LOL	1-braid, textile	Petrol, Oils, Antifreeze, Water & Air	20, 21	-40 +212	0	0	300	300	300	300	300	300	0	0	0	0	0	0	0	0	0	0
SAE 100R5, Type All	C5C	3-braid, T-W-T	Petr.Oil,Air Brake, Power Steering	15, 16, 21	-40 +212	0	0	3000	3000	2250	2000	1750	1500	800	625	500	350	350	0	0	0	0	0
SAE J1402, Type All	C5D	3-braid, T-W-T	Petrol & Syn.Fluids, Air Brakes	16, 21	-40 +300*	0	0	1500	1500	1500	1250	1250	750	400	0	0	0	0	0	0	0	0	0
SAE J1527, SAE J1942	C5M	1-braid, wire	Marine Fuel & Oil	16	-40 +212	0	0	0	500	500	500	500	500	500	0	0	0	0	0	0	0	0	0
SAE 100R7	GT7 (C7S)	1-braid, polyester	Petroleum & Synthetic Fluids	21	-65 +200	2500	2500	2750	2500	2250	2000	0	1250	1000	0	0	0	0	0	0	0	0	0

WEATHERHEAD HOSE SELECTION CHART

Standard	Industry	Description	Construction (Reinforcement)	Use	Page #	Temp Range	Dash Size vs. Rated Workign Pressure (psi)										
							-3	-4	-5	-6	-8	-10	-12	-16	-20	-24	
30R9	H077	Multi Fiber Braid	Elec. Fuel Injection	113	-30 +275	0	125	125	125	0	0	0	0	0	0	0	0
J1402/1/1, 100R1AT	H104	1 Steel Braid	Med. Pressure hyd. Lines	94-105	-40 +212	0	2750	0	2250	2000	1500	1250	1000	625	0	0	0
J1942/1, 100R17	H145	1 Steel Braid	High Pressure hyd. Lines	94-105	4-8 Size: -40 +250 10-16 Size: -40 +212	0	3045	0	3045	3045	3045	3045	3045	0	0	0	0
FDA accepted	H243	1 S. S. Braid	Teflon, high temp.	110-113	-40 +450	3000	3000	2500	2000	1750	0	1000	1000	0	0	0	0
J1942, 100R16	H245	2 Steel Braids	High Pressure, hydraulic, diesel fuel	93, 95-105	-40 +212	0	5000	0	4000	3500	2750	2250	2000	1625	0	0	0
J188 Type 2	H324	2 Fiber Braids	Power Steering	94-105	-40 +250	0	0	0	1500	0	0	0	0	0	0	0	0
USCG MSHA ABS	H425	2 Steel Braids	High Pressure hydraulic	93, 95-105	-40 +212	0	5000	0	4000	3500	2750	2250	2000	1625	1250	0	0
100R7	H435	2 Fiber Braids	Non Conductive hydraulic	110-113	-40 +200	0	2750	2500	2250	2000	0	1250	1000	0	0	0	0
100R7	H436	2 Fiber Braids	Perforated cover, hydraulic, CO2, nitrogen	110-113	-40 +200	0	2750	2500	2250	2000	0	1250	1000	0	0	0	0

THREAD IDENTIFICATION

SYNFLEX HOSE SELECTION CHART

Standard	Industry	Description	Contruccion	Use	Page #	Temp Range	Dash Size vs. Rated Workign Pressure (psi)							
			(Reinforcement)				-3	-4	-5	-6	-8	-10	-12	-16
--		3630	Spiral Synthetic Fiber	Air and Water Transfer	119	-10 +150	0	300	300	300	300	300	0	300
100R7		3130	Sprial or Braided Synthetic Fiber	Medium Pressure	117	-40 +212	2500	3000	3000	2500	2250	2000	0	1250
100R1, R7		3580	Braided Bronz Coated Steel Wire	Medium Pressure	118	-40 +225	0	0	3500	0	3250	3000	0	2250
SAE 100R12		EFG3K	4-spiral,wire	Extremely High Pressure Petrol,Oils		-40 +250	0	0	0	0	0	0	0	0
ANSI		37AL	Braided Synthetic Fiber	Non-Conductive Medium Pressure	118	-65 +212	0	3000	3000	3000	3000	3000	0	0
100R8		3R80	Braided Synthetic Fiber	High Pressure	116	-40 +212	0	5000	5000	0	4000	3500	0	2250
100R8		3800	Braided High Tensile Fiber	High Pressure	116	-40 +212	6000	5000	5000	0	4000	3500	0	0
R18		Spectra 30CT	Braided Synthetic Fiber	Constant Pressure	117	-65 +200	0	3000	3000	3000	3000	3000	3000	0